

Electrical Conduit

Construction Electricity Wiring System



Contact Details

Office.: Hangzhou / China
Tel: +86-571-28909912
Fax: +86-571-28886901
sales@prostar-ele.net
electricalpipe@188.com
www.prostar-ele.net

Everything we do is for the perfection of electric wiring

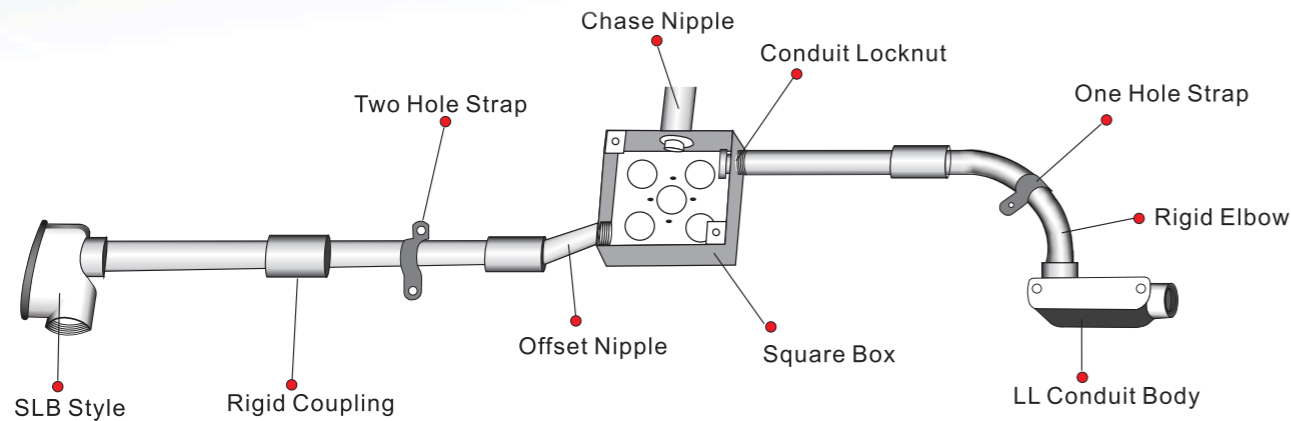

Steel Conduit & Fittings

- EMT Conduit,IMC Conduit,Rigid Steel Conduit
- EMT Connectors and Couplings
- Other Fittings for EMT Conduit
- IMC Conduit,Rigid Steel Conduit Fittings
- Conduit Body,Weatherproof Box
- Meter Socket Box
- Steel Boxes and Covers

Flex Steel Conduit & Fittings

- Flexible Steel Conduit
- PVC Coated Flexible Conduit
- Liquid Tight Conduit
- Liquid Tight Connector
- Squeeze Connector
- Other Connector

Strut Channel & Fittings

- Unistrut Channel
- Spring Nut,Thread Rods
- Strut Clamp,Conduit Hanger
- Beam Clamp
- Other Channel Fittings

Electrical Conduit Tools

- Conduit Bender
- Fish Wire Tape,Cable Puller
- PVC Bending Spring
- Cable Glands
- Terminal Blocks
- Cable Ties,Cable Clips

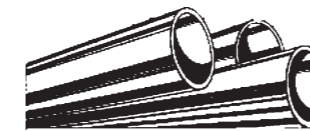

EMT Conduit Pipe Accord to ANSI C80.3, UL797

Dimensions for Standard

Finish: Pre-galvanized
Hot dip galvanized

Trade Size Designator		Nominal Outside Dia.		Nominal Wall Thickness		Two Length	
U.S.	Metric	in.	mm	in.	mm	mm	mm
1/2"	16	0.706	17.93	0.042	1.07	3000	3050
3/4"	21	0.922	23.42	0.049	1.24	3000	3050
1"	27	1.163	29.54	0.057	1.45	3000	3050
1 1/4"	35	1.510	38.35	0.065	1.65	3000	3050
1 1/2"	41	1.740	44.20	0.065	1.65	3000	3050
2"	53	2.197	55.80	0.065	1.65	3000	3050
2 1/2"	63	2.875	73.03	0.072	1.83	3000	3050
3"	78	3.500	88.90	0.072	1.83	3000	3050
3 1/2"	91	4.000	101.60	0.083	2.11	3000	3050
4"	103	4.500	114.30	0.083	2.11	3000	3050

Dimensions for Thinwall Thickness

Finish: Pre-galvanized

Trade Size Designator		Nominal Outside Dia.		Nominal Wall Thickness		Two Length	
U.S.	Metric	in.	mm	in.	mm	mm	mm
1/2"	16	0.706	17.93	0.031	0.80	3000	3050
3/4"	21	0.922	23.42	0.035	0.90	3000	3050
1"	27	1.163	29.54	0.039	1.00	3000	3050
1 1/4"	35	1.510	38.35	0.051	1.30	3000	3050
1 1/2"	41	1.740	44.20	0.051	1.30	3000	3050
2"	53	2.197	55.80	0.055	1.40	3000	3050

Note: All information available at the time of order
If you need other thickness or length pls contact us.

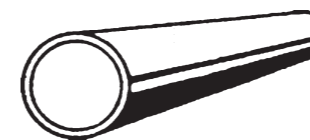

EMT Elbows

Finish: Pre-galvanized
Electro-galvanized
Hot dip galvanized

Cat.No.	Cat.No.	Size
8300	8310	1/2"
8301	8311	3/4"
8302	8312	1"
8303	8313	1 1/4"
8304	8314	1 1/2"
8305	8315	2"
8306	8316	2 1/2"
8307	8317	3"
8308	8318	3 1/2"
8309	8319	4"

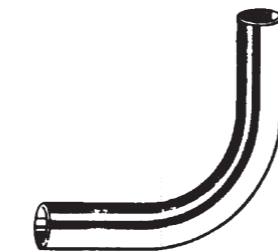

IMC Conduit Pipe Accord to ANSI C80.6, UL1242

Dimensions for Standard

Finish: Hot dip galvanized

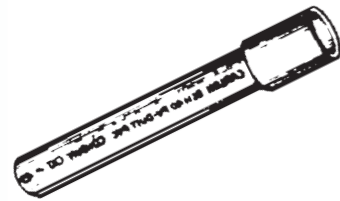

Trade Size Designator		Nominal Outside Dia.		Nominal Wall Thickness		Length	
U.S.	Metric	in.	mm	in.	mm	ft.	mm
1/2"	16	0.815	20.70	0.078	1.98	10	3000
3/4"	21	1.029	26.10	0.083	2.10	10	3000
1"	27	1.290	32.77	0.093	2.35	10	3000
1 1/4"	35	1.638	41.59	0.095	2.42	10	3000
1 1/2"	41	1.883	47.82	0.100	2.54	10	3000
2"	53	2.360	59.93	0.105	2.67	10	3000
2 1/2"	63	2.857	72.57	0.150	3.81	10	3000
3"	78	3.476	88.29	0.150	3.81	10	3000
3 1/2"	91	3.971	100.86	0.150	3.81	10	3000
4"	103	4.466	113.44	0.150	3.81	10	3000

Rigid Steel Conduit Accord to ANSI C80.1, UL6

Dimensions for Standard

Finish: Hot dip galvanized



Trade Size Designator		Nominal Outside Dia.		Nominal Wall Thickness		Length	
U.S.	Metric	in.	mm	in.	mm	ft.	mm
1/2"	16	0.840	21.34	0.104	2.64	10	3000
3/4"	21	1.050	26.67	0.107	2.72	10	3000
1"	27	1.315	33.40	0.126	3.20	10	3000
1 1/4"	35	1.660	42.16	0.133	3.38	10	3000
1 1/2"	41	1.900	48.26	0.138	3.51	10	3000
2"	53	2.375	60.33	0.146	3.71	10	3000
2 1/2"	63	2.875	73.03	0.193	4.90	10	3000
3"	78	3.500	88.90	0.205	5.21	10	3000
3 1/2"	91	4.000	101.60	0.215	5.46	10	3000
4"	103	4.500	114.30	0.225	5.72	10	3000
5"	129	5.563	141.30	0.245	6.22	10	3000
6"	155	6.625	168.30	0.266	6.76	10	3000

Dimensions for Thinwall Thickness

Finish: Pre-galvanized



Trade Size Designator		Nominal Outside Dia.		Thinner Wall Thickness		Two Length	
U.S.	Metric	in.	mm	mm	mm	mm	mm
1/2"	16	0.815	20.70	1.79	1.45	3000	3050
3/4"	21	1.029	26.10	1.90	1.45	3000	3050
1"	27	1.290	32.77	2.15	1.80	3000	3050
1 1/4"	35	1.638	41.59	2.16	2.00	3000	3050
1 1/2"	41	1.883	47.82	2.29	2.00	3000	3050
2"	53	2.360	59.93	2.41	2.00	3000	3050

Note: All information available at the time of order
If you need other thickness or length pls contact us.

Rigid Conduit Elbows

Finish: Electro-galvanized

Hot dip galvanized

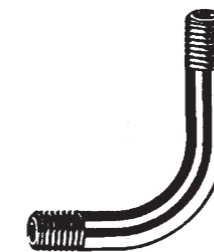

Cat.No.	Cat.No.	Size
90°	45°	
8344	8356	1/2"
8345	8357	3/4"
8346	8358	1"
8347	8359	1 1/4"
8348	8360	1 1/2"
8349	8361	2"
8350	8362	2 1/2"
8351	8363	3"
8352	8364	3 1/2"
8353	8365	4"
8354	8366	5"
8355	8367	6"

Rigid Conduit Coupling

Finish: Electro-galvanized

Hot dip galvanized

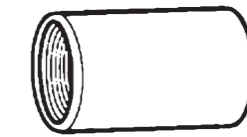

Cat.No.	Size
0324	1/2"
0325	3/4"
0326	1"
0327	1 1/4"
0328	1 1/2"
0329	2"
0330	2 1/2"
0331	3"
0332	3 1/2"
0333	4"
0334	5"
0335	6"

IMC Elbows

Finish: Pre-galvanized
Electro-galvanized
Hot dip galvanized

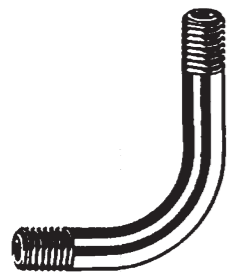

Cat.No.	Size
8320	1/2"
8321	3/4"
8322	1"
8323	1 1/4"
8324	1 1/2"
8325	2"
8326	2 1/2"
8327	3"
8328	3 1/2"
8329	4"



IMC Coupling

Electro-galvanized

Cat.No.	Size
IC-050	1/2"
IC-075	3/4"
IC-100	1"
IC-125	1 1/4"
IC-150	1 1/2"
IC-200	2"
IC-250	2 1/2"
IC-300	3"
IC-350	3 1/2"
IC-400	4"



EMT Conduit Fittings

EMT Set Screw Connectors-Zinc

- Use to Terminate EMT Pipe to Box

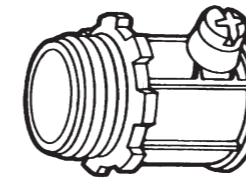

Cat.No.	Cat.No.	Conduit Size
Non-Insulated		Insulated
SSCN-050	SSCN-050I	1/2"
SSCN-075	SSCN-075I	3/4"
SSCN-100	SSCN-100I	1"
SSCN-125	SSCN-125I	1 1/4"
SSCN-150	SSCN-150I	1 1/2"
SSCN-200	SSCN-200I	2"
SSCN-250	SSCN-250I	2 1/2"
SSCN-300	SSCN-300I	3"
SSCN-400	SSCN-400I	4"

EMT Set Screw Couplings-Zinc

- Use to Couple two ends of EMT Pipe

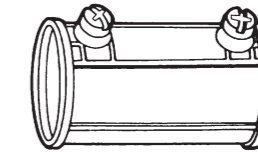

Cat.No.	Conduit Size
SSCP-050	1/2"
SSCP-075	3/4"
SSCP-100	1"
SSCP-125	1 1/4"
SSCP-150	1 1/2"
SSCP-200	2"
SSCP-250	2 1/2"
SSCP-300	3"
SSCP-400	4"

EMT Compression Connectors-Zinc

- Use to Terminate EMT Pipe to Box

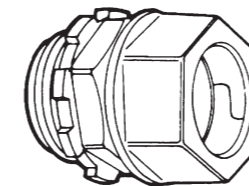

Cat.No.	Cat.No.	Conduit Size
Non-Insulated		Insulated
CCN-050	CCN-050I	1/2"
CCN-075	CCN-075I	3/4"
CCN-100	CCN-100I	1"
CCN-125	CCN-125I	1 1/4"
CCN-150	CCN-150I	1 1/2"
CCN-200	CCN-200I	2"

EMT Compression Couplings-Zinc

- Use to Couple two ends of EMT Pipe

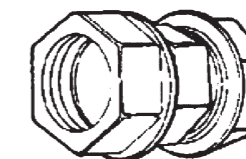

Cat.No.	Conduit Size
CCP-050	1/2"
CCP-075	3/4"
CCP-100	1"
CCP-125	1 1/4"
CCP-150	1 1/2"
CCP-200	2"

EMT Set Screw Connectors-Aluminum

- Use to Terminate EMT Pipe to Box

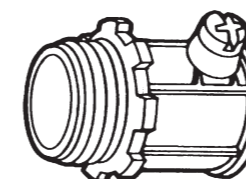

Cat.No.	Cat.No.	Conduit Size
Non-Insulated		Insulated
SSCN-050A	SSCN-050AI	1/2"
SSCN-075A	SSCN-075AI	3/4"
SSCN-100A	SSCN-100AI	1"
SSCN-125A	SSCN-125AI	1 1/4"
SSCN-150A	SSCN-150AI	1 1/2"
SSCN-200A	SSCN-200AI	2"

EMT Set Screw Couplings-Aluminum

- Use to Couple two ends of EMT Pipe

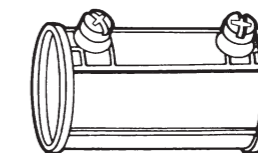

Cat.No.	Conduit Size
SSCP-050A	1/2"
SSCP-075A	3/4"
SSCP-100A	1"
SSCP-125A	1 1/4"
SSCP-150A	1 1/2"
SSCP-200A	2"



EMT Conduit Fittings

EMT Set Screw Connectors-Steel

- Use to Terminate EMT Pipe to Box

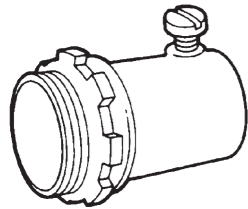

Cat.No.	Cat.No.	Conduit Size
Non-Insulated		
H-50S	H-50SI	1/2"
H-75S	H-75SI	3/4"
H-100S	H-100SI	1"
H-125S	H-125SI	1 1/4"
H-150S	H-150SI	1 1/2"
H-200S	H-200SI	2"
H-250S	H-250SI	2 1/2"
H-300S	H-300SI	3"
H-350S	H-350SI	3 1/2"
H-400S	H-400SI	4"

EMT Set Screw Couplings-Steel

- Use to Couple two ends of EMT Pipe

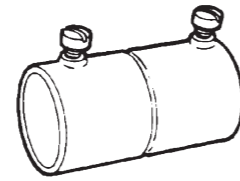

Cat.No.	Conduit Size
Z-50S	1/2"
Z-75S	3/4"
Z-100S	1"
Z-125S	1 1/4"
Z-150S	1 1/2"
Z-200S	2"
Z-250S	2 1/2"
Z-300S	3"
Z-350S	3 1/2"
Z-400S	4"

EMT Compression Connectors-Steel

- Use to Terminate EMT Pipe to Box

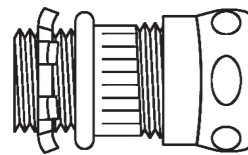

Cat.No.	Cat.No.	Conduit Size
Non-Insulated		
ZC-50S	ZC-50SI	1/2"
ZC-75S	ZC-75SI	3/4"
ZC-100S	ZC-100SI	1"
ZC-125S	ZC-125SI	1 1/4"
ZC-150S	ZC-150SI	1 1/2"
ZC-200S	ZC-200SI	2"
ZC-250S	ZC-250SI	2 1/2"
ZC-300S	ZC-300SI	3"
ZC-350S	ZC-350SI	3 1/2"
ZC-400S	ZC-400SI	4"

EMT Compression Couplings-Steel

- Use to Couple two ends of EMT Pipe

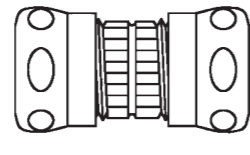

Cat.No.	Conduit Size
ZCC-50S	1/2"
ZCC-75S	3/4"
ZCC-100S	1"
ZCC-125S	1 1/4"
ZCC-150S	1 1/2"
ZCC-200S	2"
ZCC-250S	2 1/2"
ZCC-300S	3"
ZCC-350S	3 1/2"
ZCC-400S	4"

EMT Capped Corner Couplings-Zinc

- EMT Pipe to EMT Pipe

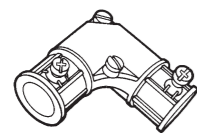

Cat.No.	Conduit Size
CCC-050	1/2"
CCC-075	3/4"
CCC-100	1"

EMT Connector Set Screw Type 90° -Zinc

- EMT Pipe to Box when 90 degree turns

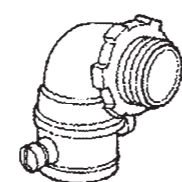

Cat.No.	Conduit Size
ECSS-075	3/4"
ECSS-100	1"
ECSS-125	1 1/4"

Steel Conduit Fittings

Watertight Hubs-Zinc

- With insulated throat

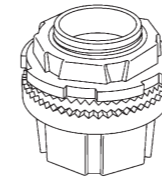

Cat.No.	Conduit Size
H-050	1/2"
H-075	3/4"
H-100	1"
H-125	1 1/4"
H-150	1 1/2"
H-200	2"
H-250	2 1/2"
H-300	3"
H-400	4"

EMT Pull Corner Elbows-Zinc

- EMT Pipe to EMT Pipe

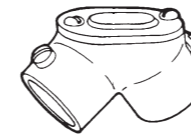

Cat.No.	Conduit Size
ETE-050	1/2"
ETE-075	3/4"
ETE-100	1"

Pull Corner Elbows-Zinc

- EMT Pipe to Box

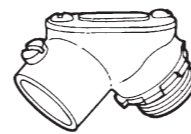

Cat.No.	Conduit Size
ETB-050	1/2"
ETB-075	3/4"
ETB-100	1"

Pull Corner Elbows-Zinc

- Rigid Conduit to Rigid Conduit

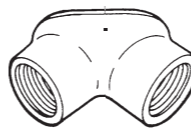

Cat.No.	Conduit Size
RTR-050	1/2"
RTR-075	3/4"
RTR-100	1"

Pull Corner Elbows-Zinc

- Rigid Conduit to Box

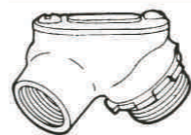

Cat.No.	Conduit Size
RTB-050	1/2"
RTB-075	3/4"
RTB-100	1"

Reducing Bushings

- Electro-galvanized Steel



Cat.No.	Conduit Size
RB-075050	3/4" x 1/2"
RB-100050	1" x 1/2"
RB-100075	1" x 3/4"
RB-125050	1 1/4" x 1/2"
RB-125075	1 1/4" x 3/4"
RB-125100	1 1/4" x 1"
RB-150050	1 1/2" x 1/2"
RB-150075	1 1/2" x 3/4"
RB-150100	1 1/2" x 1"
RB-150125	1 1/2" x 1 1/4"
RB-200050	2" x 1/2"
RB-200075	2" x 3/4"
RB-200100	2" x 1"
RB-200125	2" x 1 1/4"
RB-200150	2" x 1 1/2"

Rigid Male Enlarger-Malleable Iron

- Adapt an outlet hole to next large size



Cat.No.	Conduit Size
RME-5075	1/2" M x 3/4" F
RME-75100	3/4" M x 1" F

Rigid Male Enlarger-Steel

- Adapt an outlet hole to next large size

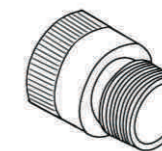

Cat.No.	Conduit Size
ME-050075	1/2" M x 3/4" F
ME-050100	1/2" M x 1" F
ME-075100	3/4" M x 1" F

EMT Combination Couplings-Zinc

- EMT Pipe to Flex

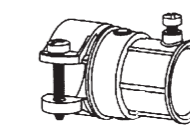

Cat.No.	Conduit Size
ESC-050	1/2"
ESC-075	3/4"
ESC-100	1"

EMT Offset Connectors-Zinc

- EMT Pipe to Box

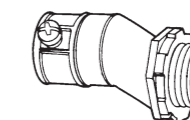

Cat.No.	Conduit Size
OFC-050	1/2"
OFC-075	3/4"
OFC-100	1"

Steel Conduit Fittings

EMT One Hole Strap

- Electro-galvanized
- Pre-galvanized



Cat.No.	Conduit Size
OSP-050	1/2"
OSP-075	3/4"
OSP-100	1"
OSP-125	1 1/4"
OSP-150	1 1/2"
OSP-200	2"
OSP-250	2 1/2"
OSP-300	3"
OSP-350	3 1/2"
OSP-400	4"

EMT Two Hole Strap

- Electro-galvanized
- Pre-galvanized

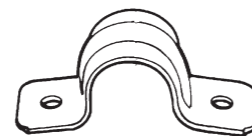

Cat.No.	Conduit Size
TSP-050	1/2"
TSP-075	3/4"
TSP-100	1"
TSP-125	1 1/4"
TSP-150	1 1/2"
TSP-200	2"
TSP-250	2 1/2"
TSP-300	3"
TSP-350	3 1/2"
TSP-400	4"

Rigid One Hole Strap

- Electro-galvanized
- Pre-galvanized

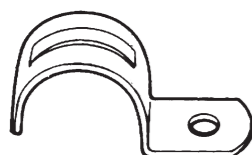

Cat.No.	Conduit Size
OSP-050R	1/2"
OSP-075R	3/4"
OSP-100R	1"
OSP-125R	1 1/4"
OSP-150R	1 1/2"
OSP-200R	2"
OSP-250R	2 1/2"
OSP-300R	3"
OSP-350R	3 1/2"
OSP-400R	4"

Rigid Two Hole Strap

- Electro-galvanized
- Pre-galvanized

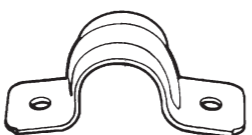

Cat.No.	Conduit Size
TSP-050R	1/2"
TSP-075R	3/4"
TSP-100R	1"
TSP-125R	1 1/4"
TSP-150R	1 1/2"
TSP-200R	2"
TSP-250R	2 1/2"
TSP-300R	3"
TSP-350R	3 1/2"
TSP-400R	4"

Strut Clamps

- Electro-galvanized
- Hot dip galvanized
- SS304 / SS316

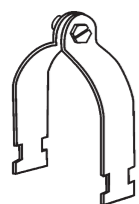

Cat.No.	Cat.No.	Conduit Size
	Rigid	
	EMT	
SC-050	SC-050E	1/2"
SC-075	SC-075E	3/4"
SC-100	SC-100E	1"
SC-125	SC-125E	1 1/4"
SC-150	SC-150E	1 1/2"
SC-200	SC-200E	2"
SC-250	-	2 1/2"
SC-300	-	3"
SC-350	-	3 1/2"
SC-400	-	4"
SC-500	-	5"
SC-600	-	6"
SC-800	-	8"

Conduit Hanger With Bolt and Nut

- Electro-galvanized
- Pre-galvanized



Cat.No.	Conduit Size
CH-050	1/2"
CH-075	3/4"
CH-100	1"
CH-125	1 1/4"
CH-150	1 1/2"
CH-200	2"
CH-250	2 1/2"
CH-300	3"
CH-350	3 1/2"
CH-400	4"

Rigid Conduit Nipples

- Electro-galvanized



Cat.No.	Pipe Size	Length
8380	1/2"	Close
8380112	1/2"	1 1/2"
83802	1/2"	2"
8380212	1/2"	2 1/2"
83803	1/2"	3"
8380312	1/2"	3 1/2"
83804	1/2"	4"
83805	1/2"	5"
83806	1/2"	6"
83808	1/2"	8"
838010	1/2"	10"
838012	1/2"	12"
8381	3/4"	Close
83812	3/4"	2"
8381212	3/4"	2 1/2"
83813	3/4"	3"
8381312	3/4"	3 1/2"
83814	3/4"	4"
83815	3/4"	5"
83816	3/4"	6"
83818	3/4"	8"
838110	3/4"	10"
838112	3/4"	12"
8382	1"	Close
83822	1"	2"
8382212	1"	2 1/2"
83823	1"	3"
8382312	1"	3 1/2"
83824	1"	4"
83825	1"	5"
83826	1"	6"
83828	1"	8"
838210	1"	10"
838212	1"	12"
8383	1 1/4"	Close
83832	1 1/4"	2"
8383212	1 1/4"	2 1/2"
83833	1 1/4"	3"
8383312	1 1/4"	3 1/2"
83834	1 1/4"	4"
83835	1 1/4"	5"
83836	1 1/4"	6"
83838	1 1/4"	8"
838310	1 1/4"	10"
838312	1 1/4"	12"



Rigid Conduit Fittings

Cat.No.	Pipe Size	Length
8384	1 1/2"	Close
83842	1 1/2"	2"
8384212	1 1/2"	2 1/2"
83843	1 1/2"	3"
8384312	1 1/2"	3 1/2"
83844	1 1/2"	4"
83845	1 1/2"	5"
83846	1 1/2"	6"
83848	1 1/2"	8"
838410	1 1/2"	10"
838412	1 1/2"	12"
8385	2"	Close
8385212	2"	2 1/2"
83853	2"	3"
8385312	2"	3 1/2"
83854	2"	4"
83855	2"	5"
83856	2"	6"
83858	2"	8"
838510	2"	10"
838512	2"	12"
8386	2 1/2"	Close
83863	2 1/2"	3"
8386312	2 1/2"	3 1/2"
83864	2 1/2"	4"
83865	2 1/2"	5"
83866	2 1/2"	6"
83868	2 1/2"	8"
838610	2 1/2"	10"
838612	2 1/2"	12"
8387	3"	Close
83873	3"	3"
8387312	3"	3 1/2"
83874	3"	4"
83875	3"	5"
83876	3"	6"
83878	3"	8"
838710	3"	10"
838712	3"	12"
8388	3 1/2"	Close
83884	3 1/2"	4"
83885	3 1/2"	5"
83886	3 1/2"	6"
83888	3 1/2"	8"
838810	3 1/2"	10"
838812	3 1/2"	12"
8389	4"	Close
83894	4"	4"
83895	4"	5"
83896	4"	6"
83898	4"	8"
838910	4"	10"
838912	4"	12"

Rigid Conduit Fittings

Rigid Set Screw Connectors-Steel

- Use to Terminate IMC/Rigid Pipe to Box



Cat.No.	Conduit Size
SSCN-050R	1/2"
SSCN-075R	3/4"
SSCN-100R	1"
SSCN-125R	1 1/4"
SSCN-150R	1 1/2"
SSCN-200R	2"

Rigid Set Screw Couplings-Steel

- Use to Couple two ends of IMC/Rigid Pipe



Cat.No.	Conduit Size
SSCP-050R	1/2"
SSCP-075R	3/4"
SSCP-100R	1"
SSCP-125R	1 1/4"
SSCP-150R	1 1/2"
SSCP-200R	2"

Rigid Compression Connectors-Steel

- Use to Terminate IMC/Rigid Pipe to Box



Cat.No.	Conduit Size
Y-RT50	1/2"
Y-RT75	3/4"
Y-RT100	1"
Y-RT125	1 1/4"
Y-RT150	1 1/2"
Y-RT200	2"

Rigid Compression Couplings-Steel

- Use to Couple two ends of IMC/Rigid Pipe



Cat.No.	Conduit Size
Y-RTC50	1/2"
Y-RTC75	3/4"
Y-RTC100	1"
Y-RTC125	1 1/4"
Y-RTC150	1 1/2"
Y-RTC200	2"

3-piece Union-Malleable Iron / Steel

- Zinc plated

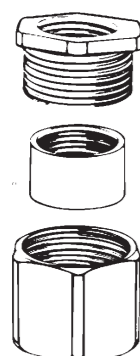

Cat.No.	Conduit Size
TPU-050	1/2"
TPU-075	3/4"
TPU-100	1"
TPU-125	1 1/4"
TPU-150	1 1/2"
TPU-200	2"
TPU-250	2 1/2"
TPU-300	3"
TPU-350	3 1/2"
TPU-400	4"
TPU-500	5"
TPU-600	6"

Conduit Nipples-Malleable Iron

- Connect Box to Conduit Coupling

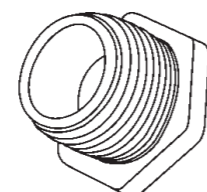

Cat.No.	Conduit Size
MCN-050	1/2"
MCN-075	3/4"
MCN-100	1"
MCN-125	1 1/4"
MCN-150	1 1/2"
MCN-200	2"
MCN-250	2 1/2"
MCN-300	3"
MCN-350	3 1/2"
MCN-400	4"
MCN-500	5"
MCN-600	6"

Steel Conduit Fittings

Steel Locknuts

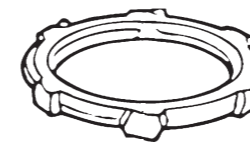

Cat.No.	Cat.No.	Conduit Size
W/Sealing		
LN-050	LN-050I	1/2"
LN-075	LN-075I	3/4"
LN-100	LN-100I	1"
LN-125	LN-125I	1 1/4"
LN-150	LN-150I	1 1/2"
LN-200	LN-200I	2"
LN-250	LN-250I	2 1/2"
LN-300	LN-300I	3"
LN-350	LN-350I	3 1/2"
LN-400	LN-400I	4"
LN-500	LN-500I	5"
LN-600	LN-600I	6"

Zinc Locknuts

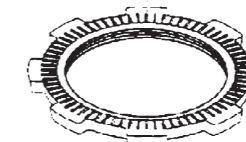

Cat.No.	Conduit Size
ZLN-050	1/2"
ZLN-075	3/4"
ZLN-100	1"
ZLN-125	1 1/4"
ZLN-150	1 1/2"
ZLN-200	2"
ZLN-250	2 1/2"
ZLN-300	3"
ZLN-350	3 1/2"
ZLN-400	4"

Conduit Bushing-Die Cast Zinc



Cat.No.	Cat.No.	Conduit Size
Non-Insulated		
CB-050	CB-050I	1/2"
CB-075	CB-075I	3/4"
CB-100	CB-100I	1"
CB-125	CB-125I	1 1/4"
CB-150	CB-150I	1 1/2"
CB-200	CB-200I	2"
CB-250	CB-250I	2 1/2"
CB-300	CB-300I	3"
CB-350	CB-350I	3 1/2"
CB-400	CB-400I	4"
Insulated		
CB-050	CB-050MI	1/2"
CB-075	CB-075MI	3/4"
CB-100	CB-100MI	1"
CB-125	CB-125MI	1 1/4"
CB-150	CB-150MI	1 1/2"
CB-200	CB-200MI	2"
CB-250	CB-250MI	2 1/2"
CB-300	CB-300MI	3"
CB-350	CB-350MI	3 1/2"
CB-400	CB-400MI	4"

Plastic Bushing-Thermoplastic

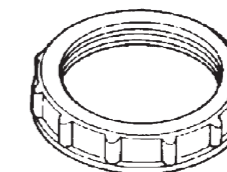

Cat.No.	Conduit Size
IPB-050	1/2"
IPB-075	3/4"
IPB-100	1"
IPB-125	1 1/4"
IPB-150	1 1/2"
IPB-200	2"
IPB-250	2 1/2"
IPB-300	3"
IPB-350	3 1/2"
IPB-400	4"

Conduit Bushing-Malleable Iron

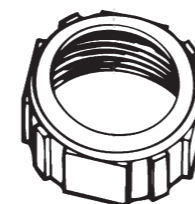

Cat.No.	Cat.No.	Conduit Size
Non-Insulated		
CB-050M	CB-050MI	1/2"
CB-075M	CB-075MI	3/4"
CB-100M	CB-100MI	1"
CB-125M	CB-125MI	1 1/4"
CB-150M	CB-150MI	1 1/2"
CB-200M	CB-200MI	2"
CB-250M	CB-250MI	2 1/2"
CB-300M	CB-300MI	3"
CB-350M	CB-350MI	3 1/2"
CB-400M	CB-400MI	4"
CB-500M	CB-500MI	5"
CB-600M	CB-600MI	6"
Insulated		
CB-050MG	CB-050MGI	1/2"
CB-075MG	CB-075MGI	3/4"
CB-100MG	CB-100MGI	1"
CB-125MG	CB-125MGI	1 1/4"
CB-150MG	CB-150MGI	1 1/2"
CB-200MG	CB-200MGI	2"
CB-250MG	CB-250MGI	2 1/2"
CB-300MG	CB-300MGI	3"
CB-350MG	CB-350MGI	3 1/2"
CB-400MG	CB-400MGI	4"
CB-500MG	CB-500MGI	5"
CB-600MG	CB-600MGI	6"

Grounding Bushing-Malleable Iron Zinc Die Cast

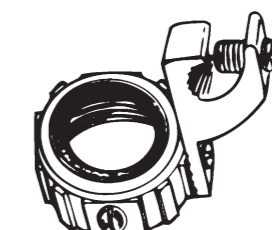

Cat.No.	Conduit Size
Insulated	
CB-050MG	1/2"
CB-075MG	3/4"
CB-100MG	1"
CB-125MG	1 1/4"
CB-150MG	1 1/2"
CB-200MG	2"
CB-250MG	2 1/2"
CB-300MG	3"
CB-350MG	3 1/2"
CB-400MG	4"
CB-500MG	5"
CB-600MG	6"

Electrical Accessories

Rigid Union Male-Steel

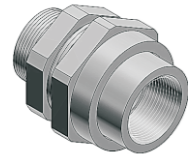

Cat.No.	Conduit Size
UNM-050	1/2"
UNM-075	3/4"
UNM-100	1"
UNM-125	1 1/4"
UNM-150	1 1/2"
UNM-200	2"
UNM-250	2 1/2"
UNM-300	3"
UNM-400	4"

Rigid Union Female-Steel



Cat.No.	Conduit Size
UNF-050	1/2"
UNF-075	3/4"
UNF-100	1"
UNF-125	1 1/4"
UNF-150	1 1/2"
UNF-200	2"
UNF-250	2 1/2"
UNF-300	3"
UNF-400	4"

Ground Rod Clamps-Bronze



Cat.No.	Conduit Size
GRC-038	3/8"
GRC-050	1/2"
GRC-058	5/8"
GRC-075	3/4"
GRC-100	1"

Split Bolt Connector-Solid Bronze



Cable Size 1	Cable Size 2
16	10-16
25	8-12
35	6-10
50-70	4-8
90-120	2(strand)
150-185	1/0
200-240	2/0
-	3/0
-	4/0
-	8-6
-	6-3
-	3-2
-	2-1/0

Grounding Terminal-Aluminum



Cat.No.	Wire Size
GT-4-14	4-14#
GT-4-1/0	4-1/0#

Knock-out Seals-Steel



Cat.No.	Size
KOS-050	1/2"
KOS-075	3/4"
KOS-100	1"
KOS-125	1 1/4"
KOS-150	1 1/2"
KOS-200	2"

Terminal Lug-Aluminum



Cat.No.	Wire Size
ATL-4	4-14
ATL-2	2-14
ATL-1/0	1/0-14
ATL-2/0	2/0-14
ATL-250	250MCM
ATL-300	300MCM
ATL-350	350MCM
ATL-500	500MCM

Electrical Accessories

Service Entrance Caps-Aluminum

- Clamp on type



Cat.No.	Conduit Size
CEC-050	1/2"
CEC-075	3/4"
CEC-100	1"
CEC-125	1 1/4"
CEC-150	1 1/2"
CEC-200	2"
CEC-250	2 1/2"
CEC-300	3"
CEC-350	3 1/2"
CEC-400	4"

Service Entrance Caps-Aluminum

- Threaded type



Cat.No.	Conduit Size
TEC-050	1/2"
TEC-075	3/4"
TEC-100	1"
TEC-125	1 1/4"
TEC-150	1 1/2"
TEC-200	2"
TEC-250	2 1/2"
TEC-300	3"
TEC-350	3 1/2"
TEC-400	4"

Round Meter Socket

Specification:

Cat.No.	Description	Hub Size
MT-100B	1Phase,100A,120/240Vac,4 Jaw	1/2"
MT-100C	1Phase,100A,120/240Vac,4 Jaw	3/4"
MT-100D	1Phase,100A,120/240Vac,4 Jaw	1"
MT-100E	1Phase,100A,120/240Vac,4 Jaw	1 1/4"

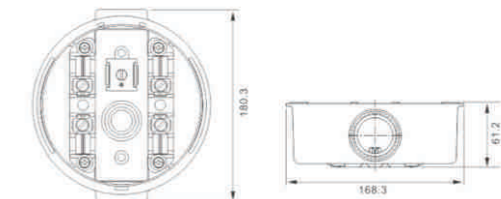

Square Meter Socket

Specification:

Cat.No.	Description	Hub Size
MT-100S-4J-H	1Phase,100A,4 Jaw,Ring type	1 1/4"
MT-100S-4J	1Phase,100A,4 Jaw,Ring type	-

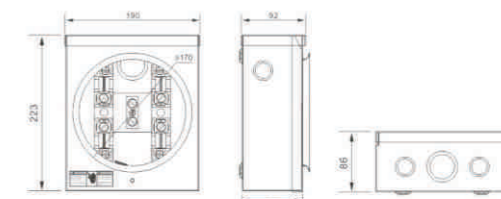

Rigid / IMC Threaded Type Conduit Body

LB Style

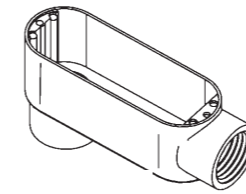

Cat.No. Aluminum	Conduit Size
LB-050	1/2"
LB-075	3/4"
LB-100	1"
LB-125	1 1/4"
LB-150	1 1/2"
LB-200	2"
LB-250	2 1/2"
LB-300	3"
LB-350	3 1/2"
LB-400	4"

LL Style

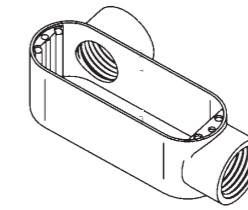

Cat.No. Aluminum	Conduit Size
LL-050	1/2"
LL-075	3/4"
LL-100	1"
LL-125	1 1/4"
LL-150	1 1/2"
LL-200	2"
LL-250	2 1/2"
LL-300	3"
LL-350	3 1/2"
LL-400	4"

LR Style

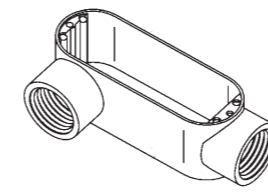

Cat.No. Aluminum	Conduit Size
LR-050	1/2"
LR-075	3/4"
LR-100	1"
LR-125	1 1/4"
LR-150	1 1/2"
LR-200	2"
LR-250	2 1/2"
LR-300	3"
LR-350	3 1/2"
LR-400	4"

C Style

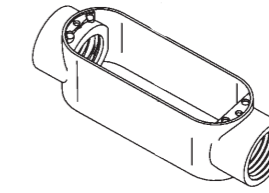

Cat.No. Aluminum	Conduit Size
C-050	1/2"
C-075	3/4"
C-100	1"
C-125	1 1/4"
C-150	1 1/2"
C-200	2"
C-250	2 1/2"
C-300	3"
C-350	3 1/2"
C-400	4"

T Style

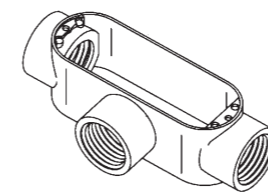

Cat.No. Aluminum	Conduit Size
T-050	1/2"
T-075	3/4"
T-100	1"
T-125	1 1/4"
T-150	1 1/2"
T-200	2"
T-250	2 1/2"
T-300	3"
T-350	3 1/2"
T-400	4"



EMT Set Screw Type Conduit Body

LBC Style

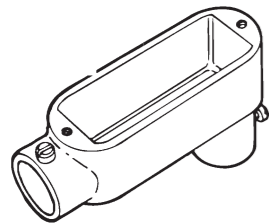

Cat.No. Aluminum	Conduit Size
LBC-050	1/2"
LBC-075	3/4"
LBC-100	1"
LBC-125	1 1/4"
LBC-150	1 1/2"
LBC-200	2"
LBC-250	2 1/2"
LBC-300	3"
LBC-350	3 1/2"
LBC-400	4"

LLC Style

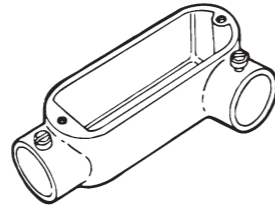

Cat.No. Aluminum	Conduit Size
LLC-050	1/2"
LLC-075	3/4"
LLC-100	1"
LLC-125	1 1/4"
LLC-150	1 1/2"
LLC-200	2"
LLC-250	2 1/2"
LLC-300	3"
LLC-350	3 1/2"
LLC-400	4"

LRC Style

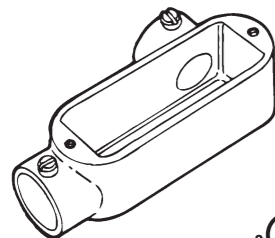

Cat.No. Aluminum	Conduit Size
LRC-050	1/2"
LRC-075	3/4"
LRC-100	1"
LRC-125	1 1/4"
LRC-150	1 1/2"
LRC-200	2"
LRC-250	2 1/2"
LRC-300	3"
LRC-350	3 1/2"
LRC-400	4"

CC Style

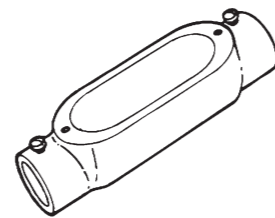

Cat.No. Aluminum	Conduit Size
CC-050	1/2"
CC-075	3/4"
CC-100	1"
CC-125	1 1/4"
CC-150	1 1/2"
CC-200	2"
CC-250	2 1/2"
CC-300	3"
CC-350	3 1/2"
CC-400	4"

TC Style

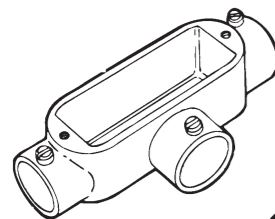

Cat.No. Aluminum	Conduit Size
TC-050	1/2"
TC-075	3/4"
TC-100	1"
TC-125	1 1/4"
TC-150	1 1/2"
TC-200	2"
TC-250	2 1/2"
TC-300	3"
TC-350	3 1/2"
TC-400	4"

Cover & Gasket Stamped Aluminum



Cat.No.	Conduit Size
SAC-050	1/2"
SAC-075	3/4"
SAC-100	1"
SAC-125/150	1 1/4"/1 1/2"
SAC-200	2"
SAC-250/300	2 1/2"/3"
SAC-350/400	3 1/2"/4"

Cover & Gasket Stamped Steel

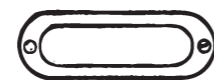

Cat.No.	Conduit Size
CF-050	1/2"
CF-075	3/4"
CF-100	1"
CF-125/150	1 1/4"/1 1/2"
CF-200	2"
CF-250/300	2 1/2"/3"
CF-350/400	3 1/2"/4"

EMT / Rigid / IMC Set Screw & Threaded Type Conduit Body

LBE Style



Cat.No. Aluminum	Conduit Size
LBE-050	1/2"
LBE-075	3/4"
LBE-100	1"
LBE-125	1 1/4"
LBE-150	1 1/2"
LBE-200	2"

LLE Style

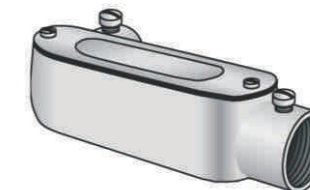

Cat.No. Aluminum	Conduit Size
LLE-050	1/2"
LLE-075	3/4"
LLE-100	1"
LLE-125	1 1/4"
LLE-150	1 1/2"
LLE-200	2"

LRE Style



Cat.No. Aluminum	Conduit Size
LRE-050	1/2"
LRE-075	3/4"
LRE-100	1"
LRE-125	1 1/4"
LRE-150	1 1/2"
LRE-200	2"

CE Style



Cat.No. Aluminum	Conduit Size
CE-050	1/2"
CE-075	3/4"
CE-100	1"
CE-125	1 1/4"
CE-150	1 1/2"
CE-200	2"

TE Style

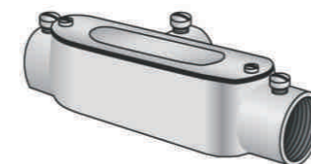

Cat.No. Aluminum	Conduit Size
TE-050	1/2"
TE-075	3/4"
TE-100	1"
TE-125	1 1/4"
TE-150	1 1/2"
TE-200	2"

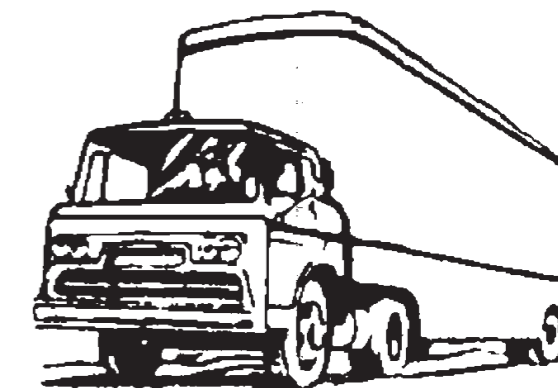

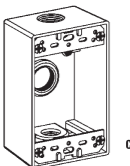

Aluminum Weatherproof Boxes

4x2" Single Gang

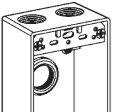
	Cat.No.	Hub Size	Deep	Outlets
Three Outlets 	1G50-3	1/2"	2"	Top 1
	1G75-3	3/4"	2"	Bottom 1
	1G100-3	1"	2"	Back 1
	1DG50-3	1/2"	2 5/8"	Total 3
	1DG75-3	3/4"	2 5/8"	
	1DG100-3	1"	2 5/8"	

	Cat.No.	Hub Size	Deep	Outlets
Four Outlets 	1G50-4	1/2"	2"	Top 2
	1G75-4	3/4"	2"	Bottom 1
	1DG50-4	1/2"	2 5/8"	Back 1
	1DG75-4	3/4"	2 5/8"	Total 4

	Cat.No.	Hub Size	Deep	Outlets
Five Outlets 	1G50-5	1/2"	2"	Top 2
	1G75-5	3/4"	2"	Bottom 2
				Back 1
			Total 5	

	Cat.No.	Hub Size	Deep	Outlets
Five Outlets(2 side) 	1G50-5X	1/2"	2"	Top 1
	1G75-5X	3/4"	2"	Bottom 1
	1DG50-5X	1/2"	2 5/8"	Side 1
	1DG75-5X	3/4"	2 5/8"	Side 1
	1DG100-5X	1"	2 5/8"	Back 1
			Total 5	

Three Gang

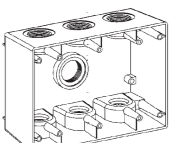
	Cat.No.	Hub Size	Deep	Outlets
	3G50-7	1/2"	2 5/8"	Top 3
	3G75-7	3/4"	2 5/8"	Bottom 3
	3G100-7	1"	2 5/8"	Back 1
				Total 7

4" Round Boxes

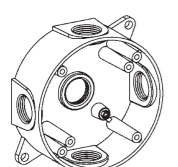
	Cat.No.	Hub Size	Deep	Outlets
	RB50-5	1/2"	1 9/16"	Bottom 1
	RB75-5	3/4"	1 9/16"	Side 1
				Side 1
				Side 1
				Side 1
			Total 5	

4x4" Two Gang

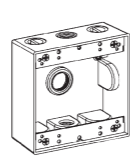
	Cat.No.	Hub Size	Deep	Outlets
Three Outlets 	2G50-3	1/2"	2 3/16"	Top 1
	2G75-3	3/4"	2 3/16"	Bottom 1
	2G100-3	1"	2 3/16"	Back 1
				Total 3

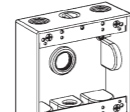
	Cat.No.	Hub Size	Deep	Outlets
Four Outlets 	2G50-4	1/2"	2 3/16"	Top 2
	2G75-4	3/4"	2 3/16"	Bottom 1
	2G100-4	1"	2 3/16"	Back 1
			Total 4	

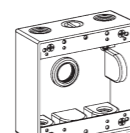
	Cat.No.	Hub Size	Deep	Outlets
Five Outlets 	2G50-5	1/2"	2 3/16"	Top 2
	2G75-5	3/4"	2 3/16"	Bottom 2
	2DG50-5	1/2"	2 5/8"	Back 1
	2DG75-5	3/4"	2 5/8"	Total 5
	2DG100-5	1"	2 5/8"	

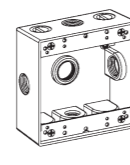
	Cat.No.	Hub Size	Deep	Outlets
Five Outlets(2 side) 	2G50-5X	1/2"	2 3/16"	Top 1
	2G75-5X	3/4"	2 3/16"	Bottom 1
	2G100-5X	1"	2 3/16"	Side 1
				Side 1
			Back 1	
			Total 5	

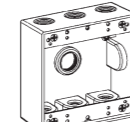
	Cat.No.	Hub Size	Deep	Outlets
Seven Outlets 	2G50-7	1/2"	2 3/16"	Top 3
	2G75-7	3/4"	2 3/16"	Bottom 3
				Back 1
			Total 7	

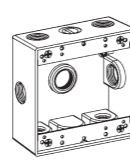
	Cat.No.	Hub Size	Deep	Outlets
Seven Outlets(2 side) 	2G50-7X	1/2"	2 3/16"	Top 2
	2G75-7X	3/4"	2 3/16"	Bottom 2
	2DG50-7X	1/2"	2 5/8"	Side 1
	2DG75-7X	3/4"	2 5/8"	Side 1
	2DG100-7X	1"	2 5/8"	Back 1
			Total 7	

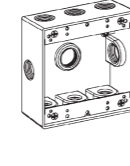
	Cat.No.	Hub Size	Deep	Outlets
Nine Outlets 	2G50-9	1/2"	2 3/16"	Top 3
	2G75-9	3/4"	2 3/16"	Bottom 3
				Side 1
			Side 1	
			Back 1	
			Total 9	

Weatherproof Boxes and Covers

Extensions-Single Gang

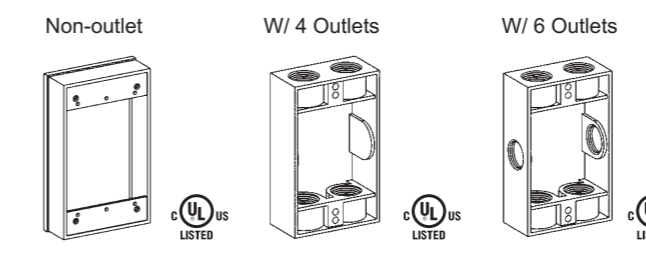

Cat.No.	Hub Size	Deep	Outlets
EXR-1	N/A	1 3/8"	0
EXB50-4	1/2"	1 3/8"	4
EXB75-4	3/4"	1 3/8"	4
EXB50-6	1/2"	1 3/8"	6
EXB75-6	3/4"	1 3/8"	6

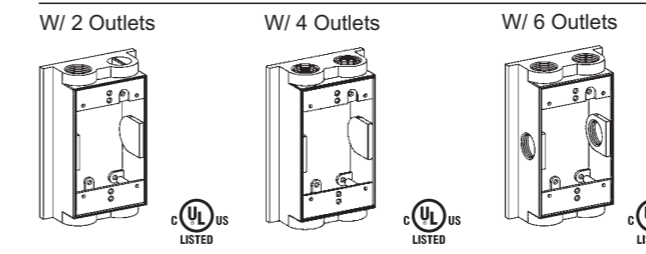

Cat.No.	Hub Size	Deep	Outlets
EXF50-2	1/2"	1 1/8"	2
EXF50-4	1/2"	1 1/8"	4
EXF75-4	3/4"	1 1/8"	4
EXF50-6	1/2"	1 1/8"	6
EXF75-6	3/4"	1 1/8"	6

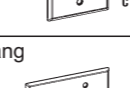
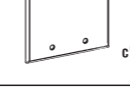

Blank Covers

	Cat.No.	Description
Round 	RBC-4	4" Round Cover
Single Gang 	1BC	1 Gang Device Mount
Two Gang 	2BC	2 Gang Device Mount
Three Gang 	3BC	3 Gang Device Mount

Extensions-Two Gang

Cat.No.	Hub Size	Deep	Outlets
EXR-2	-	1 3/8"	0
2EXB50-6	1/2"	1 3/8"	6
2EXB75-6	3/4"	1 3/8"	6
2EXB50-8	1/2"	1 3/8"	8
2EXB75-8	3/4"	1 3/8"	8

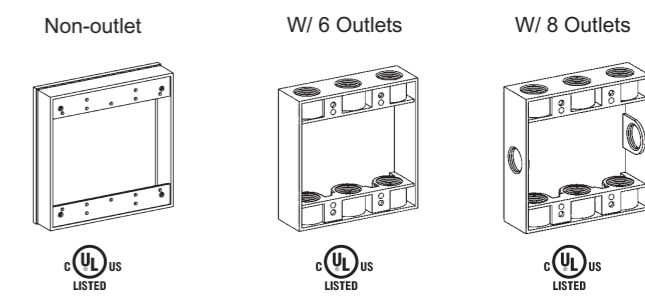

Extensions-Round

Cat.No.	Hub Size	Deep	Outlets
EXR50-4	1/2"	1 1/8"	4
EXR75-4	3/4"	1 1/8"	4

Closure Plugs

Cat.No.	Hub Size
PL-050	1/2"
PL-075	3/4"
PL-100	1"

Lampholder-Aluminum

Cat.No.	Description
LH-150-5	Inside gasket and ground screw 150W PAR 38

Lampholder Assemblies-Aluminum

Cat.No.	Description
LC23N	120V 150W PAR 38 Lamholder with Round Cover

Weatherproof Box Covers

4" Round Lamp Holder Covers Aluminum

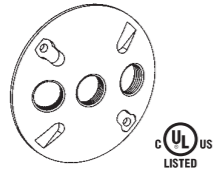

Cat.No.	Hub Size	Outlet Holes	Description
RC-1	1/2"	1	One tapped hole
RC-2	1/2"	2	Two tapped hole
RC-3	1/2"	3	Three tapped hole

Jumbo Covers-Aluminum



Cat.No.	Hub Size	Outlet Holes	Description
RC-1-N	1/2"	1	One tapped hole
RC-2-N	1/2"	2	Two tapped hole
RC-3-N	1/2"	3	Three tapped hole

Single Lamp Holder Covers Aluminum

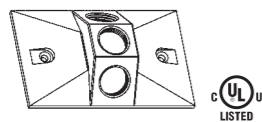

Cat.No.	Hub Size	Outlet Holes	Description
RE-1	1/2"	1	One hole device mount
RE-2	1/2"	2	Two hole device mount
RE-3	1/2"	3	Three hole device mount

Single Gang Device Covers Die Cast Zinc

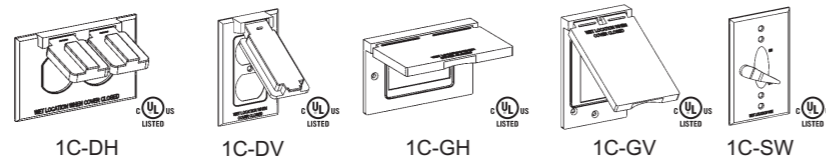

Cat.No.	Description
1C-DH	Duplex Receptacle Cover,Horizontal
1C-DV	Duplex Receptacle Cover,Vertical
1C-GH	GFCI Receptacle Cover,Horizontal
1C-GV	GFCI Receptacle Cover,Vertical
1C-SW	One Gang Cover

Two Gang Device Covers Die Cast Zinc

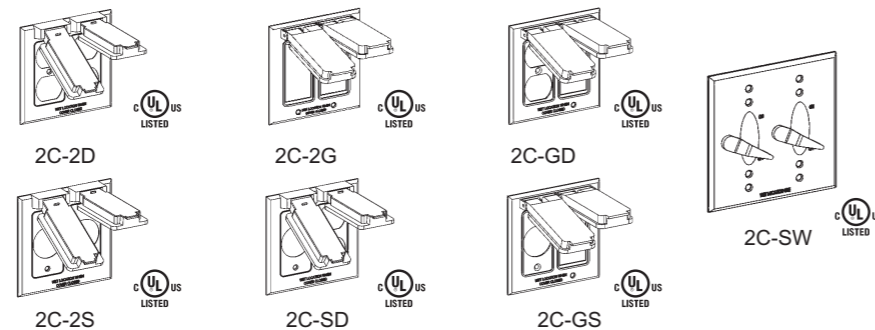

Cat.No.	Description
2C-2D	Two Duplex Receptacle Cover,Horizontal
2C-2G	Two GFCI Receptacle Cover,Vertical
2C-GD	One Duplex and one GFCI Receptacle Cover
2C-2S	Two single Receptacle Cover-1.41"Dia.opening
2C-SD	One single and One Duplex Receptacle Cover-1.41"Dia.opening
2C-GS	Single Receptacle and one GFCI Receptacle Cover-1.41"Dia.opening
2C-SW	Double Switch Cover



Square Boxes and Covers

4" Square Boxes,Drawn Type

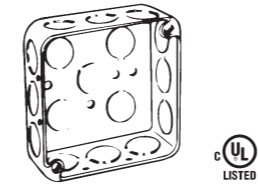

Cat.No.	Knockouts		
	EA.Side Conduit	EA.End Conduit	Bottom Conduit
1 1/2" Deep-with Conduit KO's Thickness: 0.8mm 1.0mm 1.2mm 1.5mm 1.6mm			
52151-1/2	3-1/2"	3-1/2"	5-1/2"
52151-3/4	2-3/4"	2-3/4"	5-1/2"
52151-1/2&3/4	2-1/2"	2-1/2"	3-1/2"
	1-3/4"	1-3/4"	2-3/4"
2 1/8" Deep-with Conduit KO's Thickness: 0.8mm 1.0mm 1.2mm 1.5mm 1.6mm			
52171-1/2	3-1/2"	3-1/2"	5-1/2"
52171-3/4	2-3/4"	2-3/4"	3-1/2"
52171-1/2&3/4	2-1/2"	2-1/2"	3-1/2"
	1-3/4"	1-3/4"	2-3/4"
52171-1	2-1"	2-1"	3-1/2"

4" Square Extension Rings,Drawn Type

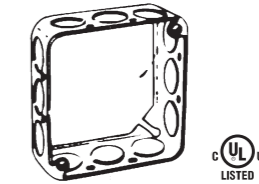

Cat.No.	Knockouts	
	EA.Side Conduit	EA.End Conduit
1 1/2" Deep-with Conduit KO's Thickness: 0.8mm 1.0mm 1.2mm 1.5mm 1.6mm		
53151-1/2	3-1/2"	3-1/2"
53151-3/4	2-3/4"	2-3/4"
53151-1/2&3/4	2-1/2"	2-1/2"
	1-3/4"	1-3/4"
2 1/8" Deep-with Conduit KO's Thickness: 0.8mm 1.0mm 1.2mm 1.5mm 1.6mm		
53171-1/2	3-1/2"	3-1/2"
53171-3/4	2-3/4"	2-3/4"
53171-1/2&3/4	2-1/2"	2-1/2"
	1-3/4"	1-3/4"
53171-1	2-1"	2-1"

4" Square Box Covers

Thickness: 0.8mm 1.0mm 1.2mm 1.5mm 1.6mm



Cat.No.	Description
52C1	Flat,blank
52C6	Flat,with 1/2" KO.
52C8	Flat,with 3/4" KO.

4" Square Device Covers

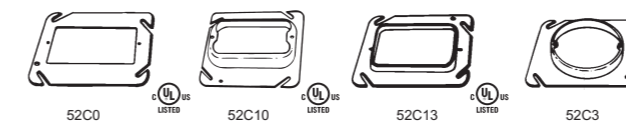

Cat.No.	Raised	Description
For Single Device,Steel Thickness: 1.0mm 1.2mm 1.5mm 1.6mm		
52C0	0	Flat
52C10	1/4"	-
52C13	1/2"	-
52C3	1/2"	W/ Mud Ring

4" Square Device Covers

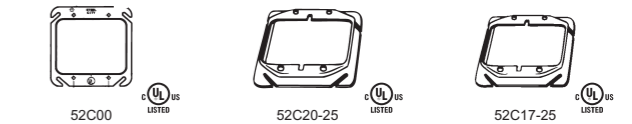

Cat.No.	Raised	Description
For Two Devices,Steel Thickness: 1.0mm 1.2mm 1.5mm 1.6mm		
52C00	0	Flat
52C20-25	1/4"	-
52C17-25	1/2"	-

Rectangular Boxes and Covers

4x2" Rectangular Boxes, Drawn Type



Cat.No.	Knockouts		
	EA.Side Conduit	EA.End Conduit	Bottom Conduit
1 1/2" Deep-with Conduit KO's Thickness: 0.8mm 1.0mm 1.2mm 1.5mm 1.6mm			
58351-1/2	3-1/2"	1-1/2"	3-1/2"
1 7/8" Deep-with Conduit KO's Thickness: 0.8mm 1.0mm 1.2mm 1.5mm 1.6mm			
58361-1/2	3-1/2"	1-1/2"	3-1/2"
58361-3/4	2-3/4"	1-3/4"	2-3/4"
58361-1/2&3/4	2-1/2" 1-3/4"	1-3/4"	2-1/2" 1-3/4"
2 1/8" Deep-with Conduit KO's Thickness: 1.2mm 1.5mm 1.6mm			
58371-1/2	3-1/2"	1-1/2"	3-1/2"
58371-3/4	2-3/4"	1-3/4"	2-3/4"
58371-1/2&3/4	2-1/2" 1-3/4"	1-3/4"	2-1/2" 1-3/4"
58371-1	2-1"	1-1"	1-1"

4x2" Rectangular Box Extension Rings

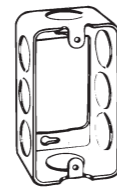

Cat.No.	Knockouts	
	EA.Side Conduit	EA.End Conduit
1 1/2" Deep-with Conduit KO's Thickness: 0.8mm 1.0mm 1.2mm 1.5mm 1.6mm		
59351-1/2	3-1/2"	1-1/2"
1 7/8" Deep-with Conduit KO's Thickness: 0.8mm 1.0mm 1.2mm 1.5mm 1.6mm		
59361-1/2	3-1/2"	1-1/2"
59361-3/4	2-3/4"	1-3/4"
59361-1/2&3/4	2-1/2" 1-3/4"	1-3/4"
2 1/8" Deep-with Conduit KO's Thickness: 1.2mm 1.5mm 1.6mm		
59371-1/2	3-1/2"	1-1/2"
59371-3/4	2-3/4"	1-3/4"
59371-1/2&3/4	2-1/2" 1-3/4"	1-3/4"
59371-1	2-1"	1-1"

4x2" Rectangular Box Covers

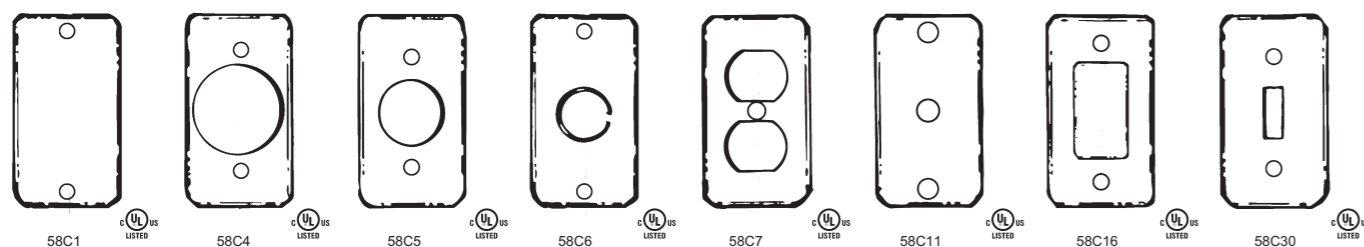

Cat.No.	Raised	Description
Raised 1/4" Thickness: 0.8mm 1.0mm 1.2mm 1.5mm 1.6mm		
58C1		Blank
58C4	1 1/32"	For 4-wire twist-lock single flush receptacle
58C5	1 1/32"	For single receptacle
58C6		With 1/2" KO.
58C7		For duplex flush receptacle
58C11		With 1 1/32" bushed hole
58C16		For single GFCI receptacle
58C30		For one toggle switch



Octagonal Boxes and Covers

4" Octagonal Boxes, Drawn Type

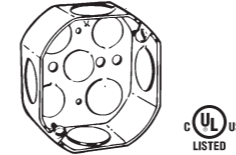

Cat.No.	Knockouts		
	EA.Side Conduit	EA.End Conduit	Bottom Conduit
1 1/2" Deep-with Conduit KO's Thickness: 0.8mm 1.0mm 1.2mm 1.5mm 1.6mm			
54151-1/2	1-1/2"	1-1/2"	5-1/2"
54151-3/4	1-3/4"	1-3/4"	3-1/2" 2-3/4"
54151-1/2&3/4	1-1/2"	1-3/4"	3-1/2" 2-3/4"
1 7/8" Deep-with Conduit KO's Thickness: 0.8mm 1.0mm 1.2mm 1.5mm			
54161-1/2	1-1/2"	1-1/2"	5-1/2"
54161-3/4	1-3/4"	1-3/4"	3-1/2" 2-3/4"
54161-1/2&3/4	1-1/2"	1-3/4"	3-1/2" 2-3/4"
2 1/8" Deep-with Conduit KO's Thickness: 0.8mm 1.0mm 1.2mm 1.5mm 1.6mm			
54171-1/2	1-1/2"	1-1/2"	5-1/2"
54171-3/4	1-3/4"	1-3/4"	3-1/2" 2-3/4"
54171-1/2&3/4	1-1/2"	1-3/4"	3-1/2" 2-3/4"
54171-1	1-1"	1-1"	3-1/2" 2-3/4"

4" Octagonal Box Extension Rings, Drawn Type

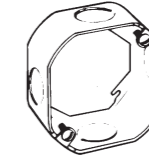

Cat.No.	Knockouts	
	EA.Side Conduit	EA.End Conduit
1 1/2" Deep-with Conduit KO's Thickness: 0.8mm 1.0mm 1.2mm 1.5mm 1.6mm		
55151-1/2	1-1/2"	1-1/2"
55151-3/4	1-3/4"	1-3/4"
55151-1/2&3/4	1-1/2"	1-3/4"



4" Octagonal Side Boxes, Drawn Type

Cat.No.	Knockouts		
	EA.Side Conduit	EA.End Conduit	Bottom Conduit
1 3/4" Deep-with Conduit KO's Thickness: 1.2mm 1.5mm 1.6mm			
54151C-1/2&3/4	1-1/2" & 3/4"	1-1/2" & 3/4"	3-1/2" 2-3/4"

4" Octagonal Box Covers

Thickness: 0.8mm 1.0mm 1.2mm 1.5mm 1.6mm



Cat.No.	Description
54C1	Flat, blank
54C6	Flat, with 1/2" KO.
54C8	Flat, with 3/4" KO.

4" Octagonal Box Round Covers

Thickness: 0.8mm 1.0mm 1.2mm 1.5mm 1.6mm

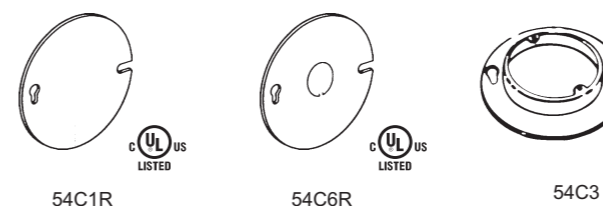

Cat.No.	Description
54C1R	Flat, blank
54C6R	Flat, with 1/2" KO.
54C8R	Flat, with 3/4" KO.
54C3	W/ Mud Ring

Square/Round Boxes and Covers

4" Square Boxes,Weld Type

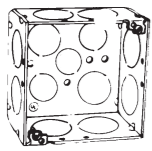

Cat.No.	Knockouts		
	EA.Side Conduit	EA.End Conduit	Bottom Conduit
2 1/8" Deep-with Conduit KO's Thickness: 1.2mm 1.5mm 1.6mm			
52171W-1/2	3-1/2"	3-1/2"	5-1/2"
52171W-3/4	2-3/4"	2-3/4"	3-1/2"
52171W-1/2&3/4	2-1/2"	2-1/2"	3-1/2"
	1-3/4"	1-3/4"	2-3/4"
52171W-1	2-1"	2-1"	3-1/2"
			2-3/4"

4-11/16" Square Boxes,Weld Type

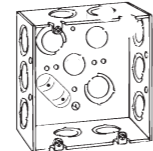

Cat.No.	Knockouts		
	EA.Side Conduit	EA.End Conduit	Bottom Conduit
2 1/8" Deep-with Conduit KO's Thickness: 1.2mm 1.5mm 1.6mm			
72171W-1/2	3-1/2"	3-1/2"	5-1/2"
72171W-3/4	2-3/4"	2-3/4"	3-1/2"
72171W-1/2&3/4	2-1/2"	2-1/2"	3-1/2"
	1-3/4"	1-3/4"	2-3/4"
72171W-1	2-1"	2-1"	3-1/2"
			2-3/4"

4" Swivel Type Cover Plates-Steel

- Square

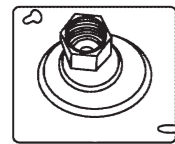

Cat.No.	Conduit Size
SCS-50	1/2" square
SCS-75	3/4" square

4" Swivel Type Cover Plates-Steel

- Round

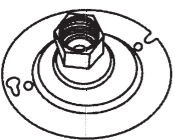

Cat.No.	Conduit Size
SCR-50	1/2" round
SCR-75	3/4" round



72C1



72C6



4-11/16" Square Boxes,Drawn Type



Cat.No.	Knockouts		
	EA.Side Conduit	EA.End Conduit	Bottom Conduit
2 1/8" Deep-with Conduit KO's Thickness: 1.2mm 1.5mm 1.6mm			
72171-1/2	3-1/2"	3-1/2"	5-1/2"
72171-3/4	2-3/4"	2-3/4"	3-1/2"
72171-1/2&3/4	2-1/2"	2-1/2"	3-1/2"
	1-3/4"	1-3/4"	2-3/4"
72171-1	2-1"	2-1"	3-1/2"
			2-3/4"
72171-1/2&1	1-1/2"	1-1/2"	3-1/2"
	1-1"	1-1"	2-3/4"
72171-3/4&1	1-3/4"	1-3/4"	3-1/2"
	1-1"	1-1"	2-3/4"

4-11/16" Square Box Cover

Thickness: 0.8mm 1.0mm 1.2mm 1.5mm 1.6mm

Cat.No.	Description
72C1	Flat,blank
72C6	Flat,with 1/2" KO.
72C8	Flat,with 3/4" KO.

Caja Metálica & Chuqui

100X65X65MM

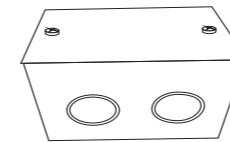

Des.

Thickness: 1.0mm 1.2mm
Finish: Pre-galvanized,Hot dip galvanized

100X100X65MM

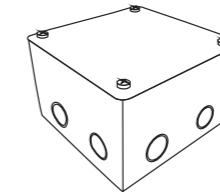

Des.

Thickness: 1.0mm 1.2mm
Finish: Pre-galvanized,Hot dip galvanized

150X150X100MM

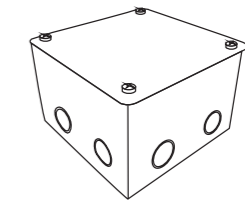

Des.

Thickness: 1.0mm 1.2mm
Finish: Pre-galvanized,Hot dip galvanized

200X100X100MM

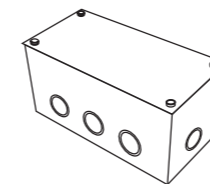

Des.

Thickness: 1.0mm 1.2mm
Finish: Pre-galvanized,Hot dip galvanized

200X200X100MM

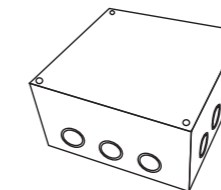

Des.

Thickness: 1.0mm 1.2mm
Finish: Pre-galvanized,Hot dip galvanized

300X200X100MM

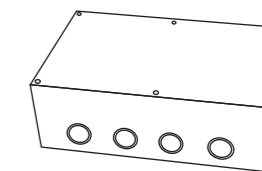

Des.

Thickness: 1.0mm 1.2mm
Finish: Pre-galvanized,Hot dip galvanized

300X200X150MM

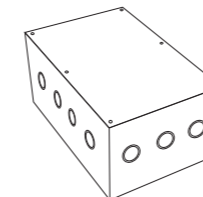

Des.

Thickness: 1.0mm 1.2mm
Finish: Pre-galvanized,Hot dip galvanized

400X300X150MM

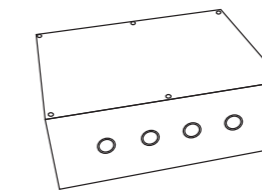

Des.

Thickness: 1.0mm 1.2mm
Finish: Pre-galvanized,Hot dip galvanized

118X76X40MM

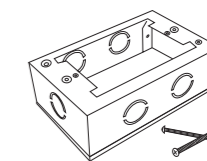

Des.

Thickness: 1.0mm 1.2mm
Finish: Pre-galvanized,Hot dip galvanized,
Yellow zinc plated

Electrial Conduit Box

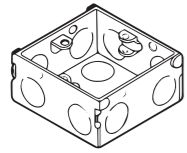

1 Gang Switch & Socket GI Box

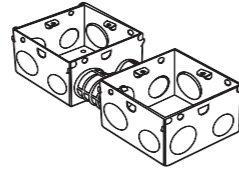

2 Gang Switch & Socket GI Box

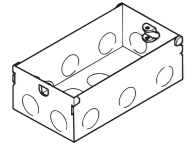

Double Switch & Socket GI Box

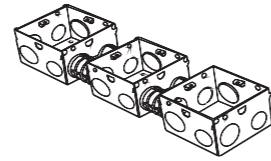

3 Gang Switch & Socket GI Box

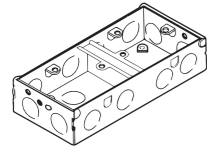

1+1 Switch & Socket GI Box

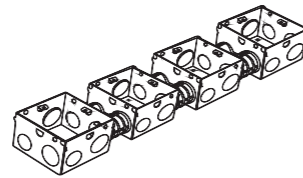

4 Gang Switch & Socket GI Box



1 Gang Switch Box Cover

Cat.#	Description
58C20	20mm K.O.
58C25	25mm K.O.

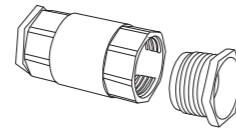

PVC Double Female Adaptor

Cat.#	Description
PDFA20	20mm
PDFA25	25mm

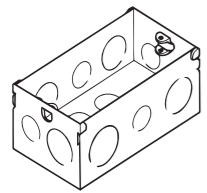

100x50mm Magic Box

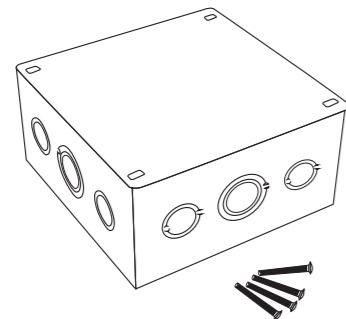

Adaptable GI Box & Cover

100x100x55	100x100x100
150x150x50	150x150x100
200x200x50	200x200x100
250x250x50	250x250x100
300x300x50	300x300x100
400x400x50	400x400x100
150x150x75	150x150x150
200x200x75	200x200x150
250x250x75	250x250x150
300x300x75	300x300x150
400x400x75	400x400x150

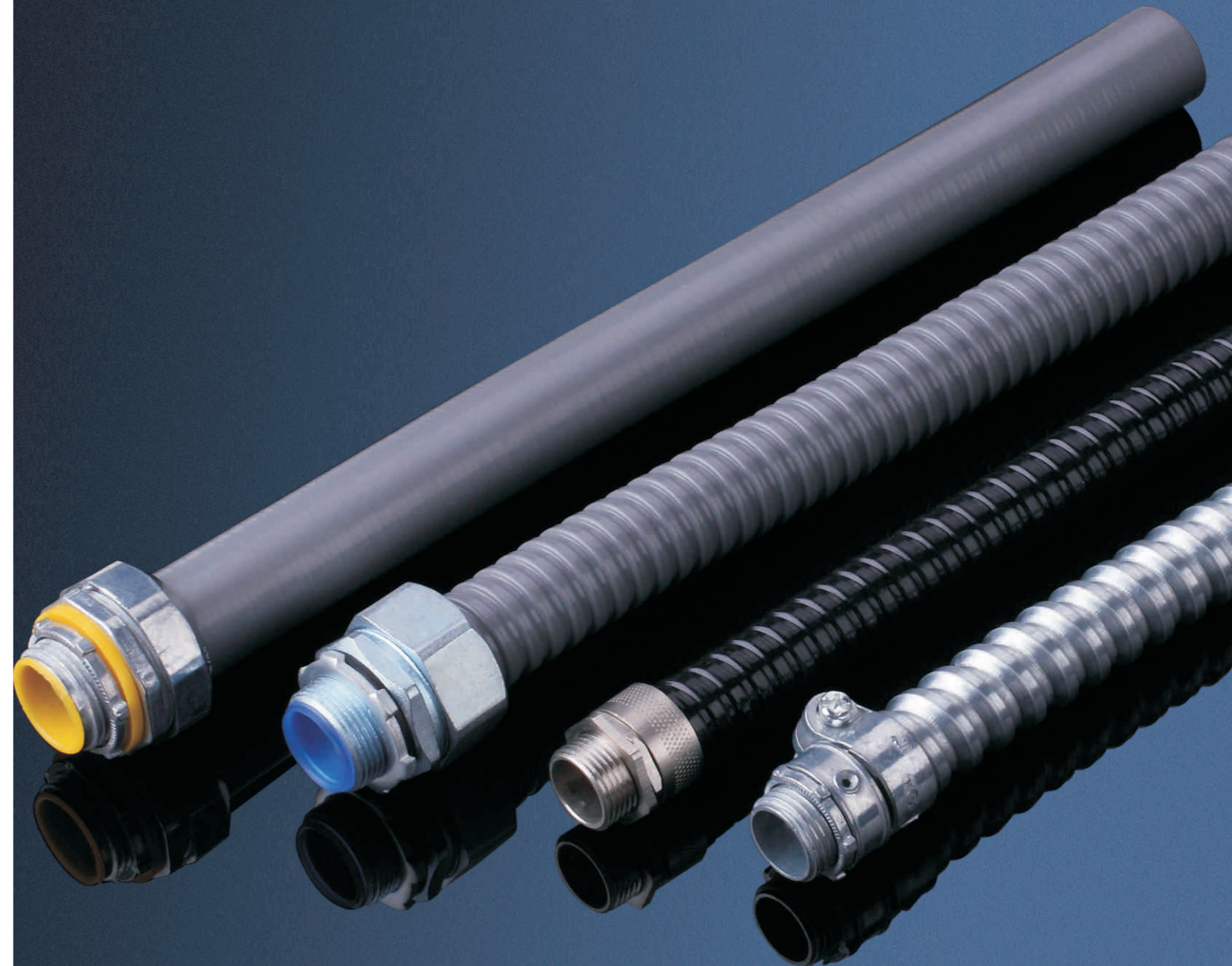

Galvanized Flexible Conduit-Economic
To South American and Middle East Market



Trade Size	Inside Dia. (mm)		Coil Length (m)
	Inside Dia. (mm)	Outside Dia. (mm)	
3/8"	13	15.5	100/50/30
1/2"	18	21	100/50/30
3/4"	22	25.5	100/50/30
1"	27	31	100/50/30
1 1/4"	35	40	50/25/20
1 1/2"	42	47	50/25/15
2"	54	62	50/15/10
2 1/2"	66	74	20/15/10
3"	78	88	20/15/10
4"	100	113	20/15/10

Other length of per coil also available

Greenfield Flexible Conduit-Heavy Duty
To American Market



Trade Size	Inside Dia. (mm)		Coil Length (m)
	Inside Dia. (mm)	Outside Dia. (mm)	
3/8"	10.0	14.8	50/30
1/2"	16.4	22.5	50/30
3/4"	20.5	26.4	50/30
1"	26.4	32.5	50/30
1 1/4"	32.5	40.2	25/15
1 1/2"	38.9	47.0	25/15
2"	51.9	61.0	15/7.5
2 1/2"	63.0	74.0	15/7.5
3"	75.0	88.0	15/7.5
4"	100.0	114.0	15/7.5

Other length of per coil also available

Liquid Tight Conduit with Filler of Cord



Trade Size	Inside Dia.(mm)		Outside Dia.(mm)		Coil Length (m)	Color
	Min.	Max.	Min.	Max.		
3/8"	12.2	12.8	17.5	18.0	100/50/30	Black/Grey
1/2"	15.8	16.3	20.8	21.3	100/50/30	
3/4"	20.7	21.3	26.0	26.7	100/50/30	
1"	26.4	27.0	32.8	33.4	100/50/30	
1 1/4"	34.6	35.8	41.4	42.2	30/15	
1 1/2"	39.8	40.6	47.4	48.3	30/15	
2"	51.3	51.9	59.4	60.3	15/7.5	
2 1/2"	62.9	63.6	72.1	73.2	10/7.5	
3"	76.0	78.7	87.9	89.0	10/7.5	
4"	98.0	102.5	113.3	114.3	10/7.5	

Other length of per coil also available

PVC Coated Flexible Conduit,Grey Color
To South American Market



Trade Size	Inside Dia. (mm)		Coil Length (m)
	Inside Dia. (mm)	Outside Dia. (mm)	
3/8"	12	16.5	100/50/30
1/2"	16	21	100/50/30
3/4"	20	25	100/50/30
1"	26	32	100/50/30
1 1/4"	35	41	50/25/15
1 1/2"	40	49	50/25/15
2"	51	60	30/15/7.5
2 1/2"	64	72	15/7.5
3"	77	86	15/7.5
4"	101	113	15/7.5

Other length of per coil also available

Squeeze Connector Straight-
Die Cast Zinc



Cat.No.	Conduit Size
Non-Insulated	
SSC-038	3/8"
SSC-050	1/2"
SSC-075	3/4"
SSC-100	1"
SSC-125	1 1/4"
SSC-150	1 1/2"
SSC-200	2"
SSC-250	2 1/2"
SSC-300	3"
SSC-400	4"

90° Squeeze Connector-
Die Cast Zinc



Cat.No.	Conduit Size
Non-Insulated	
ASC-038	3/8"
ASC-050	1/2"
ASC-075	3/4"
ASC-100	1"
ASC-125	1 1/4"
ASC-150	1 1/2"
ASC-200	2"
ASC-250	2 1/2"
ASC-300	3"
ASC-400	4"

Liquid Tight Connector Straight-
Die Cast Zinc



Cat.No.	Cat.No.	Conduit Size
Un-insulated		
SLT-038	SLT-038I	3/8"
SLT-050	SLT-050I	1/2"
SLT-075	SLT-075I	3/4"
SLT-100	SLT-100I	1"
SLT-125	SLT-125I	1 1/4"
SLT-150	SLT-150I	1 1/2"
SLT-200	SLT-200I	2"
SLT-250	SLT-250I	2 1/2"
SLT-300	SLT-300I	3"
SLT-400	SLT-400I	4"
SLT-600	SLT-600I	6"

90° Liquid Tight Connector-
Die Cast Zinc



Cat.No.	Cat.No.	Conduit Size
Un-insulated		
ALT-038	ALT-038I	3/8"
ALT-050	ALT-050I	1/2"
ALT-075	ALT-075I	3/4"
ALT-100	ALT-100I	1"
ALT-125	ALT-125I	1 1/4"
ALT-150	ALT-150I	1 1/2"
ALT-200	ALT-200I	2"
ALT-250	ALT-250I	2 1/2"
ALT-300	ALT-300I	3"
ALT-400	ALT-400I	4"

Liquid Tight Connector Straight-
Malleable Iron



Cat.No.	Cat.No.	Conduit Size
Un-insulated	Insulated	
SLT-038M	SLT-038MI	3/8"
SLT-050M	SLT-050MI	1/2"
SLT-075M	SLT-075MI	3/4"
SLT-100M	SLT-100MI	1"
SLT-125M	SLT-125MI	1 1/4"
SLT-150M	SLT-150MI	1 1/2"
SLT-200M	SLT-200MI	2"

Grounding Liquid Tight Connector Straight-
Malleable Iron



Cat.No.	Cat.No.	Conduit Size
Un-insulated	Insulated	
GSLT-038	GSLT-038I	3/8"
GSLT-050	GSLT-050I	1/2"
GSLT-075	GSLT-075I	3/4"
GSLT-100	GSLT-100I	1"
GSLT-125	GSLT-125I	1 1/4"
GSLT-150	GSLT-150I	1 1/2"
GSLT-200	GSLT-200I	2"

Screw-in Connectors-
Die Cast Zinc or Aluminum



Cat.No.	Cat.No.	Conduit Size
Zinc	Aluminum	
XC-038	XC-038A	3/8"
XC-050	XC-050A	1/2"
XC-075	XC-075A	3/4"
XC-100	XC-100A	1"

Screw-in Couplings-
Die Cast Zinc



Cat.No.	Conduit Size
XK-050	1/2"
XK-075	3/4"
XK-100	1"

45 ° Liquid Tight Connector-
Malleable Iron



Cat.No.	Cat.No.	Conduit Size
Un-insulated	Insulated	
ALT-03845	ALT-03845I	3/8"
ALT-05045	ALT-05045I	1/2"
ALT-07545	ALT-07545I	3/4"
ALT-10045	ALT-10045I	1"
ALT-12545	ALT-12545I	1 1/4"
ALT-15045	ALT-15045I	1 1/2"
ALT-20045	ALT-20045I	2"

45 ° Grounding Liquid Tight Connector-
Malleable Iron



Cat.No.	Cat.No.	Conduit Size
Un-insulated	Insulated	
GALT-03845	GALT-03845I	3/8"
GALT-05045	GALT-05045I	1/2"
GALT-07545	GALT-07545I	3/4"
GALT-10045	GALT-10045I	1"
GALT-12545	GALT-12545I	1 1/4"
GALT-15045	GALT-15045I	1 1/2"
GALT-20045	GALT-20045I	2"

One Screw Duplex Connector
Die Cast Zinc



Cat.No.	Cable Size
Non-Insulated	
OSDC-038	3/8"

Saddle type Connector-
Die Cast Zinc



Cat.No.	Cable Size
Non-Insulated	
STFC-038	3/8"

90 ° Liquid Tight Connector-
Malleable Iron



Cat.No.	Cat.No.	Conduit Size
Un-insulated	Insulated	
ALT-03890	ALT-03890I	3/8"
ALT-05090	ALT-05090I	1/2"
ALT-07590	ALT-07590I	3/4"
ALT-10090	ALT-10090I	1"
ALT-12590	ALT-12590I	1 1/4"
ALT-15090	ALT-15090I	1 1/2"
ALT-20090	ALT-20090I	2"

90 ° Grounding Liquid Tight Connector-
Malleable Iron



Cat.No.	Cat.No.	Conduit Size
Un-insulated	Insulated	
GALT-03890	GALT-03890I	3/8"
GALT-05090	GALT-05090I	1/2"
GALT-07590	GALT-07590I	3/4"
GALT-10090	GALT-10090I	1"
GALT-12590	GALT-12590I	1 1/4"
GALT-15090	GALT-15090I	1 1/2"
GALT-20090	GALT-20090I	2"

NM Cable Connector-
Die Cast Zinc



Cat.No.	Cable Size
Non-Insulated	
RTCC-050	1/2"
RTCC-075	3/4"
RTCC-100	1"
RTCC-125	1 1/4"
RTCC-150	1 1/2"
RTCC-200	2"

Combination Cable Connector-
Die Cast Zinc



Cat.No.	Cable Size
Non-Insulated	
SCCC-038	3/8" (1/2" KO.)

Liquid Tight Connector Straight-
Galvanized Steel



Cat.No.	Cat.No.	Conduit Size
Un-insulated	Insulated	
SLT-038S	SLT-038SI	3/8"
SLT-050S	SLT-050SI	1/2"
SLT-075S	SLT-075SI	3/4"
SLT-100S	SLT-100SI	1"
SLT-125S	SLT-125SI	1 1/4"
SLT-150S	SLT-150SI	1 1/2"
SLT-200S	SLT-200SI	2"



Conector A Prueba de Agua
Para Conductor 120 Voltios



Conector A Prueba de Agua
Para Conductor 240 Voltios





Non Metallic Liquid Tight Conduit

Trade Size	Inside Dia. (mm)	Outside Dia. (mm)	Reel Length (m)
1/2"	16	21	20
3/4"	20	26	15
1"	25	32	10
1 1/4"	32	40	10
1 1/2"	40	48	5
2"	51	60	5



NM Liquid Tight Connector Straight - 6/6 Nylon



Cat.No.	Conduit Size
SLT-038N	3/8"
SLT-050N	1/2"
SLT-075N	3/4"
SLT-100N	1"
SLT-125N	1 1/4"
SLT-150N	1 1/2"
SLT-200N	2"



90° NM Liquid Tight Connector- 6/6 Nylon



Cat.No.	Conduit Size
ALT-038N	3/8"
ALT-050N	1/2"
ALT-075N	3/4"
ALT-100N	1"
ALT-125N	1 1/4"
ALT-150N	1 1/2"
ALT-200N	2"



JS Type Flexible Steel Conduit- Pre-galvanized

JL Type PVC Coated Flexible Conduit- Grey Color

To South American, Middle East



Trade Size	Inside Dia. (mm)	Outside Dia. (mm)	Coil Length (m)
3/8"	12	16.5	100/50/30
1/2"	16	21	100/50/30
3/4"	20	25	100/50/30
1"	25	31	100/50/30
1 1/4"	32	38	50/25/20
1 1/2"	38	47	50/25/15
2"	51	60	50/15/10
2 1/2"	64	72	20/15/10
3"	75	84	20/15/10
4"	100	112	20/15/10
5"	125	137	5
6"	150	162	5

Other length of per coil also available

JSH Type Flexible Steel Conduit- Pre-galvanized

JLH Type PVC Coated Flexible Conduit- Grey Color

To Southeast Asia Market



Trade Size	Inside Dia. (mm)	Outside Dia. (mm)	Coil Length (m)
3/8"	13	17	50
1/2"	16	21	50
3/4"	21	26	50
1"	27	33	50
1 1/4"	35	41	50
1 1/2"	40	48	25
2"	51	60	25
2 1/2"	63	72	15
3"	78	88	10
4"	102	112	10
5"	125	137	5
6"	150	162	5

Other length of per coil also available

Galvanized Flexible Conduit, to Philippines Market



Trade Size	Inside Dia. (mm)	Outside Dia. (mm)	Reel Length (m)
3/8"	13	15.5	30
1/2"	16	19	30
3/4"	20	23	30
1"	25	29	30
1 1/4"	32	37	30
1 1/2"	38	43	30
2"	51	57.5	30

Two Screw Duplex Connector- Aluminum Die Cast or Zinc Die Cast



Cat.No.	Conduit Size
Non-Insulated	
DPC-050	1/2" x 16mm
DPC-075	3/4" X 20mm
DPC-100	1" X 25mm

Thread x Inner Dia. of Flex. Conduit

Flexible Conduit Connector, to Thailand Market Zinc Die Cast



Cat.No.	Conduit Size
Non-Insulated	
FCC-050	1/2" x 12.5mm
FCC-075	3/4" x 18.0mm
FCC-100	1" x 25.5mm

Thread x Inner Dia. of Flex. Conduit

Metal Ferrule- Galvanized Steel



Cat.No.	Conduit Size
MF-014	1/4"
MF-038	3/8"
MF-050	1/2"
MF-075	3/4"
MF-100	1"
MF-125	1 1/4"
MF-150	1 1/2"
MF-200	2"
MF-250	2 1/2"
MF-300	3"
MF-400	4"
MF-500	5"
MF-600	6"

Metal Ferrule Screw Type- Galvanized Steel



Cat.No.	Conduit Size
LXYQ-014	1/4"
LXYQ-038	3/8"
LXYQ-050	1/2"
LXYQ-075	3/4"
LXYQ-100	1"
LXYQ-125	1 1/4"
LXYQ-150	1 1/2"
LXYQ-200	2"
LXYQ-250	2 1/2"
LXYQ-300	3"
LXYQ-400	4"
LXYQ-500	5"
LXYQ-600	6"

DPJ Connector, Flex Conduit to Box- Die Cast Zinc



Cat.No.	Conduit Size
DPJ-014	1/4"
DPJ-038	3/8"
DPJ-050	1/2"
DPJ-075	3/4"
DPJ-100	1"
DPJ-125	1 1/4"
DPJ-150	1 1/2"
DPJ-200	2"
DPJ-250	2 1/2"
DPJ-300	3"
DPJ-400	4"
DPJ-500	5"
DPJ-600	6"

G thread, other thread NPT, Metric, PG also available

DPN Connector, Flex Conduit to Threaded Conduit- Die Cast Zinc



Cat.No.	Conduit Size
DPN-014	1/4"
DPN-038	3/8"
DPN-050	1/2"
DPN-075	3/4"
DPN-100	1"
DPN-125	1 1/4"
DPN-150	1 1/2"
DPN-200	2"
DPN-250	2 1/2"
DPN-300	3"
DPN-400	4"
DPN-500	5"
DPN-600	6"

G thread, other thread NPT, Metric, PG also available

DPJD Connector, Flex Conduit to Box- Die Cast Zinc



Cat.No.	Conduit Size
DPJD-014	1/4"
DPJD-038	3/8"
DPJD-050	1/2"
DPJD-075	3/4"
DPJD-100	1"
DPJD-125	1 1/4"
DPJD-150	1 1/2"
DPJD-200	2"
DPJD-250	2 1/2"
DPJD-300	3"
DPJD-400	4"
DPJD-500	5"
DPJD-600	6"

G thread, other thread NPT, Metric, PG also available

DPND Connector, Flex Conduit to Threaded Conduit- Die Cast Zinc



Cat.No.	Conduit Size
DPND-014	1/4"
DPND-038	3/8"
DPND-050	1/2"
DPND-075	3/4"
DPND-100	1"
DPND-125	1 1/4"
DPND-150	1 1/2"
DPND-200	2"
DPND-250	2 1/2"
DPND-300	3"
DPND-400	4"
DPND-500	5"
DPND-600	6"

G thread, other thread NPT, Metric, PG also available

DKJ Connector, Flex Conduit to Steel Pipe- Steel or PVC Pipe- Die Cast Zinc



Cat.No.	Conduit Size
DKJ-038	3/8"
DKJ-050	1/2"
DKJ-075	3/4"
DKJ-100	1"
DKJ-125	1 1/4"
DKJ-150	1 1/2"
DKJ-200	2"
DKJ-250	2 1/2"
DKJ-300	3"
DKJ-400	4"
DKJ-500	5"
DKJ-600	6"

DGJ Connector, Flex Conduit to Steel Pipe- Die Cast Zinc



Cat.No.	Conduit Size
DGJ-038	3/8"
DGJ-050	1/2"
DGJ-075	3/4"
DGJ-100	1"
DGJ-125	1 1/4"
DGJ-150	1 1/2"
DGJ-200	2"
DGJ-250	2 1/2"
DGJ-300	3"
DGJ-400	4"
DGJ-500	5"
DGJ-600	6"

DKJD Connector, Flex Conduit to Steel Pipe- Steel or PVC Pipe- Die Cast Zinc



Cat.No.	Conduit Size
DKJD-050	3/8"
DKJD-038	1/2"
DKJD-075	3/4"
DKJD-100	1"
DKJD-125	1 1/4"
DKJD-150	1 1/2"
DKJD-200	2"
DKJD-250	2 1/2"
DKJD-300	3"
DKJD-400	4"
DKJD-500	5"
DKJD-600	6"

DGJD Connector, Flex Conduit to Steel Pipe- Die Cast Zinc



Cat.No.	Conduit Size
DGJD-038	3/8"
DGJD-050	1/2"
DGJD-075	3/4"
DGJD-100	1"
DGJD-125	1 1/4"
DGJD-150	1 1/2"
DGJD-200	2"
DGJD-250	2 1/2"
DGJD-300	3"
DGJD-400	4"
DGJD-500	5"
DGJD-600	6"

DNJ Connector, Flex Conduit to Box 45° - Die Cast Zinc



Cat.No.	Conduit Size
DNJ-038	3/8"
DNJ-050	1/2"
DNJ-075	3/4"
DNJ-100	1"
DNJ-125	1 1/4"
DNJ-150	1 1/2"
DNJ-200	2"
DNJ-250	2 1/2"
DNJ-300	3"
DNJ-400	4"
DNJ-500	5"
DNJ-600	6"

G thread, other thread NPT, Metric, PG also available

DWJ Connector, Flex Conduit to Box 90° - Die Cast Zinc



Cat.No.	Conduit Size
DWJ-038	3/8"
DWJ-050	1/2"
DWJ-075	3/4"
DWJ-100	1"
DWJ-125	1 1/4"
DWJ-150	1 1/2"
DWJ-200	2"
DWJ-250	2 1/2"
DWJ-300	3"
DWJ-400	4"
DWJ-500	5"
DWJ-600	6"

G thread, other thread NPT, Metric, PG also available

DNJD Connector, Flex Conduit to Box 45° - Die Cast Zinc



Cat.No.	Conduit Size
DNJD-038	3/8"
DNJD-050	1/2"
DNJD-075	3/4"
DNJD-100	1"
DNJD-125	1 1/4"
DNJD-150	1 1/2"
DNJD-200	2"
DNJD-250	2 1/2"
DNJD-300	3"
DNJD-400	4"
DNJD-500	5"
DNJD-600	6"

G thread, other thread NPT, Metric, PG also available

DWJD Connector, Flex Conduit to Box 90° - Die Cast Zinc



Cat.No.	Conduit Size
DWJD-038	3/8"
DWJD-050	1/2"
DWJD-075	3/4"
DWJD-100	1"
DWJD-125	1 1/4"
DWJD-150	1 1/2"
DWJD-200	2"
DWJD-250	2 1/2"
DWJD-300	3"
DWJD-400	4"
DWJD-500	5"
DWJD-600	6"

G thread, other thread NPT, Metric, PG also available

Strut Channels

41x41 Plain/Slotted Unistrut Channel

- PL: Plain
- PG: Pre-Galvanized
- EG: Electro-Galvanized
- HDG: Hot Dip Galvanized
- SS: Stainless Steel

Dim.		Thickness	
in	mm	gauge	mm
1 5/8"	41 X 41	12	2.5
1 5/8"	41 X 41	13	2.3
1 5/8"	41 X 41	14	2.0
1 5/8"	41 X 41	15	1.8
1 5/8"	41 X 41	16	1.5
1 5/8"	41 X 41	17	1.3
1 5/8"	41 X 41	18	1.2

Standard lengths 10ft. / 3.0meter
Other length,thickness available.

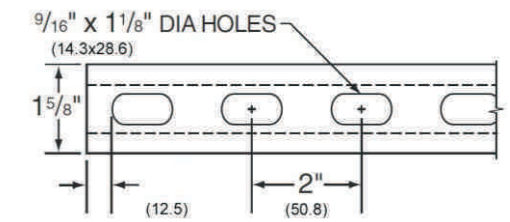
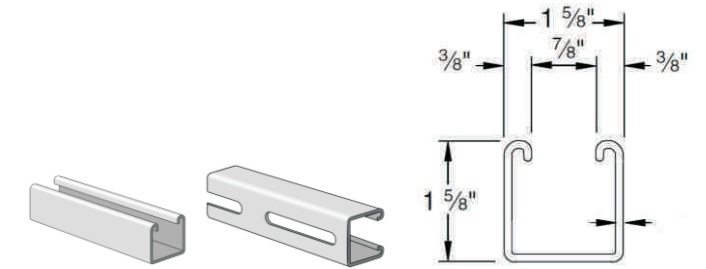

Slot Size for choose :

14.3x28.6mm
12x40mm
12x28mm
14x30mm
11x35mm

* other size also available

41x21 Plain/Slotted Unistrut Channel

- PL: Plain
- PG: Pre-Galvanized
- EG: Electro-Galvanized
- HDG: Hot Dip Galvanized
- SS: Stainless Steel

Dim.		Thickness	
in	mm	gauge	mm
1 5/8"	41 X 41	12	2.5
1 5/8"	41 X 21	13	2.3
1 5/8"	41 X 21	14	2.0
1 5/8"	41 X 21	15	1.8
1 5/8"	41 X 21	16	1.5
1 5/8"	41 X 21	17	1.3
1 5/8"	41 X 21	18	1.2

Standard lengths 10ft. / 3.0meter
Other length,thickness available.

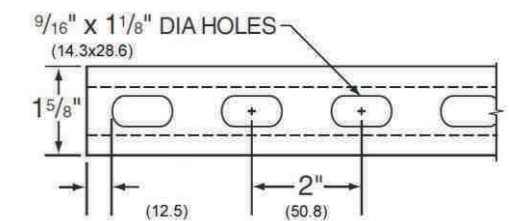
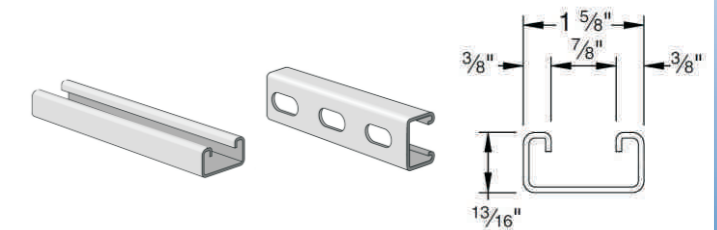

Slot Size for choose :

14.3x28.6mm
12x40mm
12x28mm
14x30mm
11x35mm

* other size also available



Fasteners

All Thread Rods

UNC Thread

- PL: Plain
- EG: Electro-Galvanized
- HDG: Hot Dip Galvanized
- SS: Stainless Steel



Standard lengths 10ft./3.0meter
Other length also available.

Cat.No.	Thread Size
TR-14	1/4"-20
TR-516	5/16"-18
TR-38	3/8"-16
TR-12	1/2"-13
TR-58	5/8"-11
TR-34	3/4"-10
TR-78	7/8"-9
TR-1	1"-8

Channel Nuts,UNC Thread

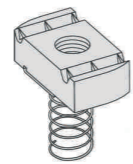

Long Spring

EG: Electro-Galvanized
HDG: Hot Dip Galvanized
SS: Stainless Steel

Thread Size	Nut Specification		Thickness mm
	Length mm	Width mm	
1/4"-20	34.5	19	6.0
5/16"-18	34.5	19	6.0/8.0
3/8"-16	34.5	19	8.0/9.2
7/16"-14	34.5	19	8.0/9.2
1/2"-13	34.5	19	9.2/11.8
5/8"-11	34.5	30	11.0
3/4"-10	34.5	30	11.0
7/8"-9	34.5	30	11.0

Channel End Cap

- Plastic

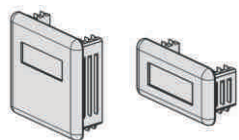

Cat.No.	Channel Size
EC-1	41x21
EC-2	41x41

Riel RC (Tipo H Briones)

- Yellow Zinc Plated

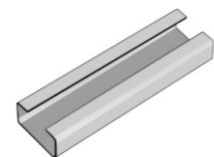

Dim. mm	Thickness mm
35x19	1.2

Drop in Anchor

UNC Thread

- Zinc / Yellow Plated

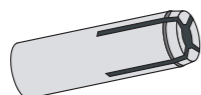

Cat.No.	Thread Size	Drill Diameter	Length (In)	Weight kgs/KPCS
DIA-14	1/4"-20	3/8"	1"	9.6
DIA-516	5/16"-18	3/8"	1-1/4"	9.8
DIA-38	3/8"-16	1/2"	1-9/16"	25
DIA-12	1/2"-13	5/8"	2"	49.5
DIA-58	5/8"-11	7/8"	2-1/2"	135
DIA-34	3/4"-10	1"	3-3/18"	196

Rod Coupler

UNC Thread

- Zinc Plated
- Stainless Steel

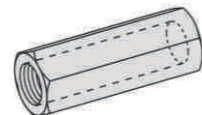

Cat.No.	Thread Size	Across Flat	Length (In)	Weight kgs/KPCS
RC-14	1/4"-20	3/8"	7/8"	9.0
RC-516	5/16"-18	1/2"	7/8"	18
RC-38	3/8"-16	1/2"	1-1/8"	19
RC-12	1/2"-13	1 1/16"	1-3/4"	52
RC-58	5/8"-11	1 3/16"	2-1/8"	82
RC-34	3/4"-10	1"	2-1/4"	136
RC-78	7/8"-9	1-1/4"	2-1/2"	270

Fasteners

Standard Top Hat Punched Din Rail

- Yellow Zinc Plated
- Electro - Galvanized

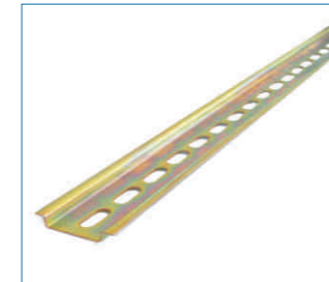

Plain		Slotted	
Cat No.	Length	Cat No.	Length
DR35-10	1.0m	DR35-10S	1.0m
DR35-20	2.0m	DR35-20S	2.0m

* Available in full and perforated versions, in various lengths.

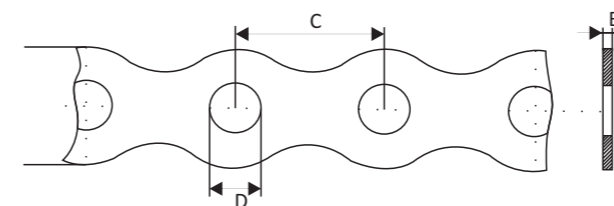

Rounded Gal. Perforated Banding

Material : Pre-galvanized

Cat. No.	AXB (mm)	D (mm)	C (mm)	Lth's/Roll
RPB-120810	12x0.8	5.0	14	10M
RPB-170810	17x0.8	7.0	20	10M
RPB-261010	26x1.0	8.0	25	10M

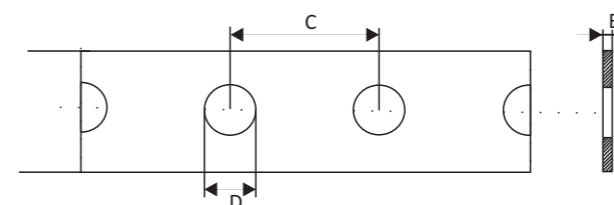

Straight Gal. Perforated Banding

Material : Pre-galvanized

Cat. No.	AXB (mm)	D (mm)	C (mm)	Lth's/Roll
SPB-120810	12x0.8	5.0	8	10M
SPB-170810	17x0.8	7.0	12	10M
SPB-200810	20x0.8	8.0	12	10M
SPB-261010	26x1.0	8.0	12	10M

Strut Channel Accessories

Standard Clevis Hanger

- Electro-Galvanized



Cat.No.	Conduit Size	Rod Size
HDCH-050	1/2"	1/4"
HDCH-075	3/4"	1/4"
HDCH-100	1"	1/4"
HDCH-125	1 1/4"	1/4"
HDCH-150	1 1/2"	1/4"
HDCH-200	2"	1/4"
HDCH-250	2 1/2"	3/8"
HDCH-300	3"	3/8"
HDCH-350	3 1/2"	3/8"
HDCH-400	4"	3/8"
HDCH-500	5"	1/2"
HDCH-600	6"	1/2"
HDCH-800	8"	5/8"
HDCH-1000	10"	3/4"
HDCH-1200	12"	3/4"

Universal Strut Clamps, Pre-assembled For EMT, IMC, GC, Pipe, or O.D. Tube.

- EG: Electro-Galvanized



Cat.No.	Conduit Size	O.D. mm
SC-050U	1/2"	17.93-21.34
SC-075U	3/4"	23.42-26.67
SC-100U	1"	29.54-33.40
SC-125U	1 1/4"	38.35-42.16
SC-150U	1 1/2"	44.20-48.26
SC-200U	2"	55.80-60.33

RC Pipe Clamps for 35x19mm Channel

- White Zinc Plated
- Yellow Zinc Plated



Cat.No.	Conduit Size	O.D. mm
SC-050S	1/2"	21.34
SC-075S	3/4"	26.67
SC-100S	1"	33.40
SC-125S	1 1/4"	42.16
SC-150S	1 1/2"	48.26
SC-200S	2"	60.33
SC-250S	2 1/2"	73.03
SC-300S	3"	88.90
SC-350S	3 1/2"	101.60
SC-400S	4"	114.30
SC-500S	5"	141.30
SC-600S	6"	168.30
SC-800S	8"	219.08

Conduit Fastener

- Black Enamel



Cat.No.	Conduit Size
CFN-5075	1/2"-3/4"
CFN-100	1"
CFN-125	1 1/4"
CFN-150	1 1/2"
CFN-200	2"

Swivel Band Hanger

- Pre-Galvanized
- Electro-Galvanized
- Copper Plated



Cat.No.	Conduit Size	Rod Size	O.D. mm
S-050	1/2"	3/8"	21.34
S-075	3/4"	3/8"	26.67
S-100	1"	3/8"	33.40
S-125	1 1/4"	3/8"	42.16
S-150	1 1/2"	3/8"	48.26
S-200	2"	3/8"	60.33
S-250	2 1/2"	3/8"	73.03
S-300	3"	3/8"	88.90
S-350	3 1/2"	3/8"	101.6
S-400	4"	3/8"	114.3
S-500	5"	1/2"	141.3
S-600	6"	1/2"	168.3
S-800	8"	1/2"	219.1

Cushion Clamp

- Yellow Zinc Plated
- With TPR Sleeve



Cat.No.	Tube O.D.
SC-14	1/4"
SC-38	3/8"
SC-12	1/2"
SC-58	5/8"
SC-34	3/4"
SC-78	7/8"
SC-118	1 1/8"
SC-138	1 3/8"
SC-158	1 5/8"
SC-218	2 1/8"
SC-258	2 3/8"
SC-318	3 1/8"
SC-418	4 1/8"

G Clamp

- Standard finish—Zinc Plated



Cat.No.	Thickness
CBC-1	2.5mm
CBC-2	3.0mm

Channel Washer

- Electro-Galvanized
- Hot Dip Galvanized



Cat.No.	Rods Size
WSR-14	1/4"
WSR-516	5/16"
WSR-38	3/8"
WSR-12	1/2"

Riser Clamps

- Electro-Galvanized
- Copper Plated



Cat.No.	Conduit Size	Cat.No.	Conduit Size
RC-050	1/2"	RC-500	5"
RC-075	3/4"	RC-600	6"
RC-100	1"	RC-800	8"
RC-125	1 1/4"	RC-1000	10"
RC-150	1 1/2"	RC-1200	12"
RC-200	2"	RC-1400	14"
RC-250	2 1/2"	RC-1600	16"
RC-300	3"	RC-1800	18"
RC-350	3 1/2"	RC-2000	20"
RC-400	4"		

One-piece Cable Clamp

- Electro-Galvanized



Cat.No.	Cable Size mm
OPC-14	8-12
OPC-16	12-16
OPC-20	16-22
OPC-26	22-28
OPC-32	28-34
OPC-40	34-40
OPC-46	40-46
OPC-52	46-52
OPC-58	52-58
OPC-66	58-64
OPC-70	64-70
OPC-78	70-78



Pipe Clamp with EPDM or without

Trade Size	D (mm)	bxS (mm)	M (mm)	G
3/8"	15-19	20x1.5	M6x20	M8+M10
1/2"	20-25	20x1.5	M6x20	M8+M10
3/4"	26-30	20x1.5	M6x20	M8+M10
1"	32-36	20x1.5	M6x20	M8+M10
1 1/4"	38-43	20x1.5	M6x20	M8+M10
1 1/2"	47-51	20x1.5	M6x20	M8+M10
2"	60-64	20x1.5	M6x20	M8+M10
2 1/2"	75-80	20x1.5	M6x20	M8+M10
3"	87-92	20x1.5	M6x20	M8+M10
3 1/2"	99-105	20x1.5	M6x20	M8+M10
4"	113-118	20x1.5	M6x20	M8+M10
5"	138-142	20x1.5	M6x20	M8+M10
6"	159-166	20x1.5	M6x20	M8+M10
8"	200-212	20x1.5	M6x20	M8+M10

Strut Channel Accessories

Top Beam Clamps- Malleable Iron

- Standard finish—
Plain or Galvanized



Cat.No.	Rod Size	Open Size (mm)
375-38	3/8"	3/4"
375-12	1/2"	3/4"

Beam Clamps- Malleable Iron

- Standard finish—
Plain or Galvanized



Cat.No.	Rod Size	Open Size (mm)
TBC-M06	M6	18.5
TBC-M08	M8	18.5
TBC-M10	M10	20.0
TBC-M12	M12	30.0
TBC-M14	M14	35.0

Top Beam Clamps- Malleable Iron

- Standard finish—
Plain or Galvanized



Cat.No.	Rod Size	Open Size
BC-3414	1/4"	3/4"
BC-3438	3/8"	3/4"
BC-3412	1/2"	3/4"
BC-11438	3/8"	1-1/4"
BC-11412	1/2"	1-1/4"

Universal Beam Clamps- Malleable Iron

- Standard finish—
Plain or Galvanized



Cat.No.	Rod Size	Open Size
103-38	3/8"	3/4"
103-12	1/2"	3/4"
103-38B	3/8"	1-1/8"

Swing Hanger-Steel

- Standard finish—
Yellow Zinc Plated



Cat.No.	Size
SHBC-38	3/8"
SHBC-50	1/2"

Wide Mouth Beam Clamps- Malleable Iron

- Standard finish—
Plain or Galvanized



Cat.No.	Rods Size	Open Size
400-38	3/8"	1-1/4"
400-12	1/2"	1-1/4"

Beam Clamps for Mounting Channel

- Standard finish—
Galvanized



Cat.No.	A Size
MCBC-1	3-3/8"
MCBC-2	5"

Insulator Support Beam Clamps

- Standard finish—
Zinc Plated



Cat.No.	Rod Size	Tapping	Open Size
BC-14	5/16"	1/4"	1"
BC-38	1/2"	3/8"	2"
BC-12	1/2"	1/2"	2-1/2"

Electrical Conduit Tools





Conduit Bender with Handle- Aluminum

Item No.	Conduit Size	
	EMT	Rigid
ACB-050H	1/2"	-
ACB-075H	3/4"	1/2"
ACB-100H	1"	3/4"

Conduit Bender without Handle- Aluminum



Item No.	Conduit Size	
	EMT	Rigid
ACB-050	1/2"	-
ACB-075	3/4"	1/2"
ACB-100	1"	3/4"

Conduit Bender- Ductile Iron



Item No.	Conduit Size	
	EMT	Rigid
SCB-050	1/2"	-
SCB-075	3/4"	1/2"
SCB-100	1"	3/4"
SCB-125	1 1/4"	1"

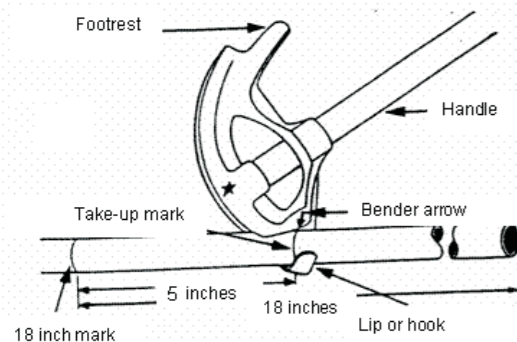

Natural Color / Zinc Plated

Metal Cable Puller with Riveted Terminals A type (Eyelet+Eyelet)

Item No.	Specification	Length(m)
	Width(mm) x Thickness(mm)	
MCP-3205A/MCP-5005A	3.2 x 0.5/5.0x0.5	5
MCP-3210A/MCP-5010A	3.2 x 0.5/5.0x0.5	10
MCP-3215A/MCP-5015A	3.2 x 0.5/5.0x0.5	15
MCP-3220A/MCP-5020A	3.2 x 0.5/5.0x0.5	20
MCP-3225A/MCP-5025A	3.2 x 0.5/5.0x0.5	25
MCP-3230A/MCP-5030A	3.2 x 0.5/5.0x0.5	30



Natural Color / Zinc Plated

Metal Cable Puller with Riveted Terminals B type (Eyelet + Flex Metallic starting Spinner with Ball)

Item No.	Specification	Length(m)
	Width(mm) x Thickness(mm)	
MCP-3205B/MCP-5005B	3.2 x 0.5/5.0x0.5	5
MCP-3210B/MCP-5010B	3.2 x 0.5/5.0x0.5	10
MCP-3215B/MCP-5015B	3.2 x 0.5/5.0x0.5	15
MCP-3220B/MCP-5020B	3.2 x 0.5/5.0x0.5	20
MCP-3225B/MCP-5025B	3.2 x 0.5/5.0x0.5	25
MCP-3230B/MCP-5030B	3.2 x 0.5/5.0x0.5	30

Metal Cable Puller with Riveted Terminals C type (Eyelet + Roller)

Item No.	Specification	Length(m)
	Width(mm) x Thickness(mm)	
MCP-3205C/MCP-5005C	3.2 x 0.5/5.0x0.5	5
MCP-3210C/MCP-5010C	3.2 x 0.5/5.0x0.5	10
MCP-3215C/MCP-5015C	3.2 x 0.5/5.0x0.5	15
MCP-3220C/MCP-5020C	3.2 x 0.5/5.0x0.5	20
MCP-3225C/MCP-5025C	3.2 x 0.5/5.0x0.5	25
MCP-3230C/MCP-5030C	3.2 x 0.5/5.0x0.5	30



Natural Color / Zinc Plated

Steel Spiral Cable Puller

Small Roll with Brass Fixed Terminals (Spinner + Eyelet)

Item No.	Solid Diameter(mm)	Length(m)
SSCP-3005	Φ 3.2	5
SSCP-3010	Φ 3.2	10
SSCP-3015	Φ 3.2	15
SSCP-3020	Φ 3.2	20
SSCP-3025	Φ 3.2	25
SSCP-3030	Φ 3.2	30



Natural Color / Zinc Plated

Nylon Cable Puller, Small Roll with Brass Fixed Terminals

(Flex starting Spinner with Ball and Eyelet on the back side of Fish Tape)



Item No	Solid Diameter(mm)	Length(m)
NCP-3005/NCP-4005	Φ3 / Φ4	5
NCP-3010/NCP-4010	Φ3 / Φ4	10
NCP-3015/NCP-4015	Φ3 / Φ4	15
NCP-3020/NCP-4020	Φ3 / Φ4	20
NCP-3025/NCP-4025	Φ3 / Φ4	25
NCP-3030/NCP-4030	Φ3 / Φ4	30

Nylon Cable Puller, Small Roll with Brass Interchangeable Terminals

(Flex starting Spinner with Eyelet and Eyelet on the back side of Fish Tape)



Item No	Solid Diameter(mm)	Length(m)
NCP-4005D	Φ4	5
NCP-4010D	Φ4	10
NCP-4015D	Φ4	15
NCP-4020D	Φ4	20
NCP-4025D	Φ4	25
NCP-4030D	Φ4	30

Nylon Cable Puller with Brass Fixed Terminals

(Eyelet+Eyelet)



Item No	Solid Diameter(mm)	Length(m)
NCP-4505	Φ4.5	5
NCP-4510	Φ4.5	10
NCP-4515	Φ4.5	15
NCP-4520	Φ4.5	20
NCP-4525	Φ4.5	25
NCP-4530	Φ4.5	30

Fiberglass Filling Cable Puller with Brass Fixed Terminals

(Flex starting Spinner with Ball and Eyelet on the back side of Fish Tape)

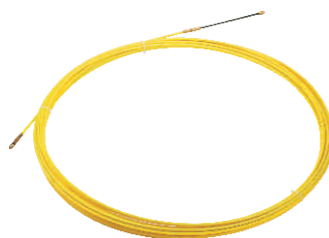

Item No	Solid Diameter(mm)	Length(m)
FCP-3005	Φ3.0	5
FCP-3010	Φ3.0	10
FCP-3015	Φ3.0	15
FCP-3020	Φ3.0	20
FCP-3025	Φ3.0	25
FCP-3030	Φ3.0	30



Fiberglass Filling Cable Puller with Steel Fixed Terminals

(Eyelet+Eyelet)

Item No	Solid Diameter(mm)	Length(m)
FCP-4005	Φ4.0	5
FCP-4010	Φ4.0	10
FCP-4015	Φ4.0	15
FCP-4020	Φ4.0	20
FCP-4025	Φ4.0	25
FCP-4030	Φ4.0	30

More Rod Filling Cable Puller, Small Roll with Nickel Plated Brass Terminals

(Interchangeable Flex starting Spinner with Ball and Fixed Eyelet on the back side of Fish Tape)



Item No	Solid Diameter(mm)	Length(m)
MRCP-4005	Φ4.0	5
MRCP-4010	Φ4.0	10
MRCP-4015	Φ4.0	15
MRCP-4020	Φ4.0	20
MRCP-4025	Φ4.0	25
MRCP-4030	Φ4.0	30

Single Rod Filling Cable Puller with Nickel Plated Brass Terminals

(Interchangeable Flex starting Spinner with Ball and Fixed Eyelet on the back side of Fish Tape)



Item No	Solid Diameter(mm)	Length(m)
SRCP-4005	Φ4.0	5
SRCP-4010	Φ4.0	10
SRCP-4015	Φ4.0	15
SRCP-4020	Φ4.0	20
SRCP-4025	Φ4.0	25
SRCP-4030	Φ4.0	30

Twine Polyester Cable Puller with Galvanized Steel Terminals

(Flex starting Spinner with Eyelet and Eyelet on the back side of Fish Tape)



Item No	Solid Diameter(mm)	Length(m)
PCP-6015	Φ6.0	15
PCP-6020	Φ6.0	20
PCP-6025	Φ6.0	25
PCP-6030	Φ6.0	30
PCP-6040	Φ6.0	40
PCP-6050	Φ6.0	50



* Special Head for choose



* All kinds of Cable Puller available inside;
* Orange Shell for choose
* OEM also acceptable



* All kinds of Cable Puller available inside;
* Special head for choose
* OEM also acceptable

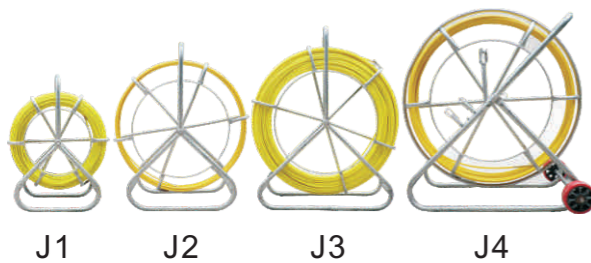

J1 J2 J3 J4

High Strength Steel Fish Wire Tap (Small Roll)

Item No.	Specification Width(mm) x Thickness(mm)	Length(m)
NFWT-10S	3.0 x 1.3	10
NFWT-15S	3.0 x 1.3	15
NFWT-20S	3.0 x 1.3	20
NFWT-25S	3.0 x 1.3	25
NFWT-30S	3.0 x 1.3	30

High Strength Steel Fish Wire Tap (Big Roll)

Item No.	Specification Width(mm) x Thickness(mm)	Length(m)
FWT-30	3.0 x 1.3	30
FWT-40	3.0 x 1.3	40
FWT-45	3.0 x 1.3	45
FWT-50	3.0 x 1.3	50
FWT-60	3.0 x 1.3	60
FWT-75	3.0 x 1.3	75
FWT-100	3.0 x 1.3	100

High Strength Steel Fish Wire Tap (Big Roll)

Item No.	Specification Width(mm) x Thickness(mm)	Length(m)
NFWT-30	3.0 x 1.3	30
NFWT-40	3.0 x 1.3	40
NFWT-45	3.0 x 1.3	45
NFWT-50	3.0 x 1.3	50
NFWT-60	3.0 x 1.3	60
NFWT-75	3.0 x 1.3	75
NFWT-100	3.0 x 1.3	100

Fiberglass Cable Puller

Item No.	Cable Puler Size Width(mm)	Length(m)
D05L100	5.0	100
D11L050	11.0	50
D06L150	6.0	150
D14L050	14.0	50

Type.	Wire Rack(cm)	O.D.
J1	40(L)x15(W)x50(H)	40CM
J2	55(L)x17(W)x64(H)	55CM
J3	65(L)x17(W)x73(H)	65CM
J4	90(L)x33(W)x100(H)	90CM



Internal Bending Spring for Heavy Duty PVC Pipe

Finish: Natural,White Zinc Plated,Color Zinc Plated,Black Coating

Item No.	Size	Length(mm)
IBSH-16550	16	550
IBSH-20550	20	550
IBSH-25550	25	550
IBSH-32550	32	550

Other size or length also available

Internal Bending Spring for Medium PVC Pipe

Finish: Natural,White Zinc Plated,Color Zinc Plated,Black Coating

Item No.	Size	Length(mm)
IBSM-16550	16	550
IBSM-20550	20	550
IBSM-25550	25	550
IBSM-32550	32	550

Other size or length also available

Internal Bending Spring for Light Duty PVC Pipe

Finish: Natural,White Zinc Plated,Color Zinc Plated,Black Coating

Item No.	Size	Length(mm)
IBSL-16550	16	550
IBSL-20550	20	550
IBSL-25550	25	550
IBSL-32550	32	550

Other size or length also available

External Bending Spring for PVC Pipe

Finish: Natural,White Zinc Plated,Yellow Zinc Plated,Black Coating

Item No	Size	Length(mm)
EBS-16550	16	550
EBS-20550	20	550
EBS-25550	25	550
EBS-32550	32	550

Other size or length also available

Cable Glands

Material:
Body: Nickel Plated Brass
Seal: Polymeide 66
Sealing: NBR
IP68



PG Thread

Size	Cable Diameter	Thread Length
Pg7	3-7	6
PG9	4-8	7
PG9	6-10	7
PG11	6-10	7
PG13.5	8-12	8
PG13.5	4-8	8
PG13.5	6-10	7
PG13.5	10-14	8
PG16	10-14	8
PG16	8-12	8
PG19	10-14	8
PG21	13-18	8
PG21	10-16	8
PG25	13-18	8
PG29	18-25	9
PG36	25-32	10
PG36	18-25	10
PG42	32-38	10
PG48	37-44	12
PG63	43-52	15

G Thread

Size	Cable Diameter	Thread Length
G-1/4"	3-7	6
G-3/8"	4-8	7
G-3/8"	6-10	7
G-1/2"	8-12	8
G-1/2"	4-8	8
G-1/2"	10-14	8
G-3/4"	13-18	8
G-1"	15-22	9
G-1 1/4"	22-28	10
G-1 1/2"	25-32	10
G-1 1/2"	18-25	10
G-2"	37-44	12
G-2 1/2"	42-52	15
G-3"	65-70	18

NPT Thread

Size	Cable Diameter	Thread Length
1/4"	3-7	6
3/8"	4-8	7
1/2"	8-12	8
3/4"	13-18	8
1"	15-22	9
1 1/4"	22-28	9
1 1/2"	25-32	10
2"	37-44	12
2 1/2"	42-52	15
3"	65-70	18

Metric Thread

Size	Cable Diameter	Thread Length
M8*1.0	3-7	6
M10*1.0	3-7	6
M12*1.5	3-7	6
M14*1.5	3-7	6
M16*1.5	4-8	7
M16*1.5	6-10	7
M18*1.5	6-10	7
M20*1.5	8-12	8
M20*1.5	4-8	7
M20*1.5	6-10	7
M20*1.5	10-14	7
M22*1.5	10-14	8
M22*1.5	8-12	8
M24*1.5	10-14	8
M25*1.5	10-14	8
M25*1.5	9-16	8
M25*1.5	13-18	8
M27*1.5(2)	13-18	8
M27*1.5(2)	10-16	8
M30*1.5(2)	13-18	8
M30*1.5(2)	10-16	8
M30*1.5(2)	15-20	8
M32*1.5(2)	15-22	9
M32*1.5(2)	13-18	8
M32*1.5(2)	18-25	9
M33*1.5(2)	15-22	9
M36*1.5(2)	18-25	9
M36*1.5(2)	15-22	9
M37*1.5(2)	18-25	9
M40*1.5(2)	22-28	10
M40*1.5(2)	18-25	9
M40*1.5(2)	22-30	10
M40*1.5(2)	22-32	10
M42*1.5(2)	22-28	10
M42*1.5(2)	22-30	10
M48*1.5(2)	25-32	10
M50*1.5(2)	25-32	10
M50*1.5(2)	32-38	12
M54*1.5(2)	32-38	12
M56*1.5(2)	32-38	12
M60*1.5(2)	37-44	12
M63*1.5(2)	37-44	12
M63*1.5(2)	42-53	15
M64*1.5(2)	37-44	12
M72*1.5(2)	42-52	15
M75*1.5(2)	42-52	15
M76*1.5(2)	42-52	15
M80*1.5(2)	50-62	16
M85*1.5(2)	50-62	16
M85*1.5(2)	60-70	18
M88*1.5(2)	60-70	18
M90*1.5(2)	60-70	18
M100*1.5(2)	70-80	20

Plastic Cable Glands

Material: Nylon
Color: grey or black
IP67



PG Thread

Size	Cable Diameter	Thread Length
PG7	3-6.5	8/15
PG7	2-5	8/15
PG9	4-8	8/15
PG9	2-6	8/15
PG11	5-10	8/15
PG11	3-7	8/15
PG13.5	6-12	9/15
PG13.5	5-9	9/15
PG16	10-14	10/15
PG16	7-12	10/15
PG19	12-15	10
PG19	10-12	10
PG21	13-18	10/15
PG21	9-16	10/15
PG25	16-21	11
PG25	13-18	11
PG29	18-25	12/18
PG29	13-20	12/18
PG36	22-32	14/18
PG36	20-26	14/18
PG42	32-38	14/18
PG42	25-31	14/18
PG48	37-44	14/18
PG48	29-35	14/18
PG63	42-50	27

Metric Thread

Size	Cable Diameter	Thread Length
M12*1.5	3-6.5	8/15
M12*1.5	2-5	8/15
M16*1.5	4-8	8/15
M16*1.5	2-6	8/15
M18*1.5	5-10	8/15
M18*1.5	3-7	8/15
M20*1.5	6-12	9/15
M20*1.5	5-9	9/15
M20*1.5	10-14	15
M20*1.5	7-12	15
M22*1.5	10-14	10/15
M22*1.5	7-12	10/15
M24*1.5	12-15	10
M24*1.5	10-12	10
M25*1.5	13-18	10/15
M25*1.5	9-16	10/15
M27*1.5	13-18	10
M27*1.5	9-16	10
M30*1.5	16-21	11
M30*1.5	13-18	11
M32*1.5	16-21	11
M32*1.5	13-18	11
M36*1.5	18-25	12
M36*1.5	13-20	12
M40*1.5	22-32	14/18
M40*1.5	20-26	14/18
M50*1.5	32-38	14/18
M50*1.5	25-31	14/18
M63*1.5	37-44	14/18
M63*1.5	29-35	14/18

G / NPT Thread

Size	Cable Diameter	Thread Length
1/4"	3-6.5	8
3/8"	4-8	15
1/2"	6-12	13
3/4"	13-18	15
1"	18-25	16
1 1/4"	18-25	18
1 1/2"	22-32	15
2"	37-44	15

Self-Locking Nylon Cable Ties

Color: Natural (or white,standard color)
 UV Black and other colors are available as requested

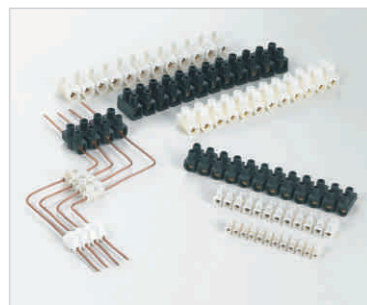
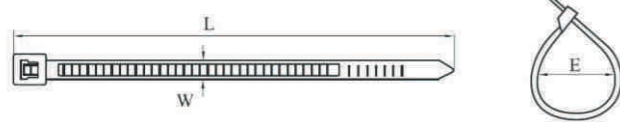

Terminal Blocks

Material: PA,PE or PP
 Type: H,U(W),V(F)

Item No	L	W	H	A	B	mm ²	Volt	Amp
TBS-3A	90.3	15.5	10.8	6.0	8.0	4	400V	3A
TBS-5A	110.7	15.5	12.5	6.5	9.5	6	400V	5A
TBS-10A	117.5	20	15.0	8.4	10.5	10	400V	10A
TBS-16A	137.5	22	17.0	10.3	12.0	12	400V	16A
TBS-20A	155	25	19.2	11.5	13.5	14	400V	20A
TBS-30A	166.7	25.5	20.0	12.0	14.5	16	400V	30A
TBS-60A	188	29	23.5	13.5	16.5	25	400V	60A
TBS-80A	205	33	27.0	15.0	17.0	35	400V	80A
TBS-100A	250	46	31.0	22.0	21.0	40	400V	100A

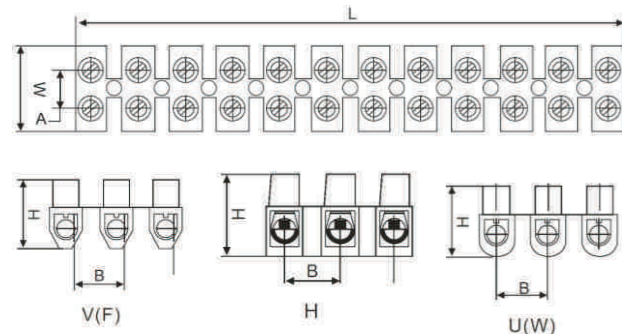

Item No.	Length		Width	Bundle Dia.
	inch	mm	mm	mm
SLCT-2.5x80	3 ³ / ₁₆ "	80	2.5	2-16
SLCT-2.5x100	4"	100	2.5	2-22
SLCT-2.5x120	4 ³ / ₄ "	120	2.5	2-30
SLCT-2.5x150	6"	150	2.5	2-35
SLCT-2.5x200	8"	200	2.5	2-50
SLCT-3.6x150	6"	150	3.6	3-35
SLCT-3.6x180	7"	180	3.6	3-42
SLCT-3.6x200	8"	200	3.6	3-50
SLCT-3.6x250	10"	250	3.6	3-65
SLCT-3.6x300	11 ⁵ / ₈ "	300	3.6	3-80
SLCT-3.6x370	14 ¹ / ₂ "	370	3.6	3-102
SLCT-4.8x200	8"	200	4.8	3-50
SLCT-4.8x250	10"	250	4.8	3-65
SLCT-4.8x300	11 ⁵ / ₈ "	300	4.8	3-80
SLCT-4.8x350	13 ³ / ₄ "	350	4.8	3-90
SLCT-4.8x370	14 ¹ / ₂ "	370	4.8	3-102
SLCT-4.8x400	15 ³ / ₄ "	400	4.8	3-105
SLCT-4.8x450	17 ³ / ₄ "	450	4.8	3-130
SLCT-4.8x500	19 ¹ / ₁₆ "	500	4.8	3-150
SLCT-7.6x200	8"	200	7.6	3-50
SLCT-7.6x250	10"	250	7.6	4-65
SLCT-7.6x300	11 ⁵ / ₈ "	300	7.6	4-80
SLCT-7.6x350	13 ³ / ₄ "	350	7.6	4-90
SLCT-7.6x380	15"	380	7.6	4-100
SLCT-7.6x400	15 ³ / ₄ "	400	7.6	4-105
SLCT-7.6x450	17 ³ / ₄ "	450	7.6	4-110
SLCT-7.6x500	19 ¹ / ₁₆ "	500	7.6	4-150
SLCT-7.6x550	21 ¹ / ₁₆ "	550	7.6	4-160
SLCT-7.6x700	27 ¹ / ₂ "	700	7.6	4-195
SLCT-9.0x400	15 ³ / ₄ "	400	9.0	8-105
SLCT-9.0x450	17 ³ / ₄ "	450	9.0	8-118
SLCT-9.0x500	19 ¹ / ₁₆ "	500	9.0	8-150
SLCT-9.0x550	21 ¹ / ₁₆ "	550	9.0	8-160
SLCT-9.0x600	23 ³ / ₅ "	600	9.0	8-170
SLCT-9.0x650	25 ⁹ / ₁₆ "	650	9.0	8-185
SLCT-9.0x720	27 ¹ / ₂ "	720	9.0	10-195
SLCT-9.0x760	29 ⁹ / ₁₆ "	760	9.0	10-225
SLCT-9.0x800	31 ⁹ / ₁₆ "	800	9.0	10-230
SLCT-9.0x900	35 ¹ / ₂ "	900	9.0	10-265
SLCT-9.0x1000	40 ¹ / ₁₆ "	1000	9.0	10-300

